



Standardized Sales Catalog Office and Field Copy

www.FireplaceandChimneyAuthority.com



120 E. Lake St., Elmhurst, IL 60126
1702 Ogden Ave, Lisle, IL 60532

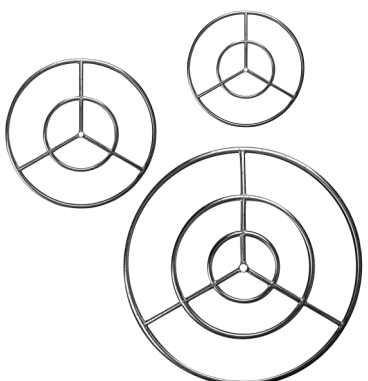

Table of Contents





Air-Cooled Temp/Guard Pipe	25	Firestarters	40
Aluminum Liner Kits and Parts	13	Gas Connectors	82
Black Stove Pipe	29	Gas Mixers	9
Burner Pipes	9	Gas Valve Floor Plates	8
Chase Tops	35	Gas Valve Keys	8
Chimney Caps	32	Gas Valves	9, 82
Chimney Insulation	37	Liner Kits and Parts	10
Chimney Liner	31	Outdoor Burners	3
Contemporary Fireplace Burners/Media	6, 74	Pot Topers	34
Direct Vent Piping	16	Radiant Fireplace Burners & Logs	65
Electric Fireplace Inserts	77	Skamolex	76
Exhausto Fans	30	Stainless Steel Liner Kits and Parts	10
Fire Grates	43, 45, 46	Temp/Guard 2100° Pipe	25
Fireglass	6	TracPipe	83
Firepit Assemblies and Parts	3, 45	Vent Caps	11, 16, 20
Fireplace & Chimney Maintenance	40	Vent Connectors	12
Fireplace Air Vents	38	Vent Free Fireplace Burners	66
Fireplace Ash and Damper Parts	36, 44	Vent Free Fireplace Logs	66
Fireplace Decorative Accessories	75	Vent Tees	11, 16, 20
Fireplace Firebacks, Tools & Screens	46, 76	Vent Top Plates	12
Fireplace Log Maintenance	41	Vented Fireplace Burners	60
Fireplace Parts / Valves / Remotes	76, 82	Vented Fireplace Logs	48
Fireplace Smoke Guards	36	Wood Burning Pipe and Venting	29

Outdoor Burners

Fireglass +

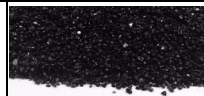
Model	Item #	Stocked	MSRP	
H-Burners	FGP-H-18	Yes	90.00	
	FGP-H-24	Yes	110.00	
	FGP-H-30	Yes	120.00	
Fire Pit Rings	FGP-R-18	Yes	120.00	
	FGP-R-24	Yes	170.00	
	FGP-R-30	Yes	210.00	

Fire Pit Media from Fireglass +

Color	Item #	Stocked	Style	MAP	
Black Sand	FGP-BS-10 10 lbs	Yes		30.00	
Black Lava	FGP-OL-S-10 10 lbs	Yes	3/8-in	30.00	
Black Lava	FGP-OL-M-10 10 lbs	Yes	1-in	30.00	
Rolled Black Lava	FGP-RL-S-20 20 lbs	Yes	1-in to 2-inch	69.00	
Rolled Black Lava	FGP-RL-M-20 20 lbs	Yes	2-in to 4-inch	89.00	



In-Stock Items Available within 24 hours or can be picked up from our warehouse!

Non-Stock items normally available within 7-10 Business Days

Additional Items Available ~ Check Manufacturer Pricelists



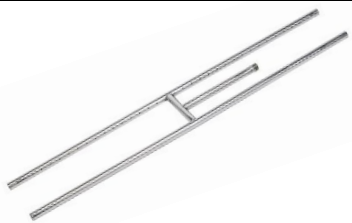
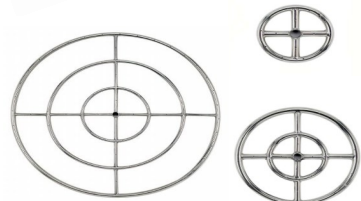



Outdoor Burners

American Fireglass

Model	Item #	Stocked	MSRP	
H-Burners	SS-H-12	Yes	88.00	
	SS-H-36	Yes	144.00	
	SS-H-48	Yes	176.00	
Fire Pit Rings	SS-FR-6	Yes	88.00	
	SS-FR-12	Yes	122.00	
	SS-FR-36	Yes	276.00	
Rectangular Drop-In Fire Pit Pan	SS-AFPP-18	Yes	232.00	
	SS-AFPP-24	Yes	276.00	
	SS-AFPP-30	Yes	346.00	
	SS-AFPP-36	Non-Stock	460.00	
	SS-AFPP-48	Yes	632.00	
Linear Drop-In Channel Burner	SS-LCB-30	Non-Stock	300.00	
	SS-LCB-36	Non-Stock	346.00	
	SS-LCB-48	Non-Stock	460.00	
	SS-LCB-60	Non-Stock	632.00	
	SS-LCB-72	Non-Stock	690.00	

RealFyre

Model	Item #	Stocked	MSRP	
Triple T Burner	G45-24-SS	Yes	362.50	
	G45-30-SS	Yes	411.50	







 <i>Golden Blount</i>		Outdoor Burners by Golden Blount		 <i>Golden Blount</i>	
Model	Item #	Stocked	MSRP		
Grand Fire Pit	Spoke Burner-20	Yes	230.00		
	Spoke Burner-14	Yes	170.00		
	GFP-36-PAN	Yes	390.00		
	GFP-24-PAN	Yes	340.00		
		GFP-36 Logs	Yes	1075.00	
		GFP-24 Logs	Yes	690.00	
		GFP-STAND	Yes	140.00	
		GFP-STAND-24	Yes	130.00	
		Lava Rock-40#	Yes	50.00	
Linear Fire Pans	LFP-36	Yes	175.00		
	LFP-48	Yes	210.00		
	LFP-60	Yes	240.00		
	LFP-72	Yes	285.00		
	LFP-96	Yes	345.00		
Rectangular Fire Pans	RFP-1212	Yes	175.00		
	RFP-1224	Yes	215.00		
	RFP-1236	Yes	250.00		
	RFP-2424	Yes	295.00		
	RFP-2436	Yes	395.00		

In-Stock Items Available within 24 hours or can be picked up from our warehouse!
 Non-Stock items normally available within 7-10 Business Days
 Additional Items Available ~ Check Manufacturer Pricelists



Fireglass +

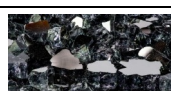
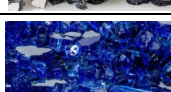

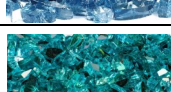
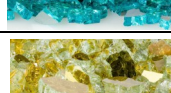

Color	Item #	Stocked	Style	MAP	
Crystal Ice	H-CI-1 10 lbs	Yes	1/2"	65.00	
Bronze	H-BR-1 10 lbs	Yes	1/2" Reflective	65.00	
Copper	H-CR-1 10 lbs	Yes	1/2" Reflective	65.00	
Midnight Black	H-MBR-1 10 lbs	Yes	1/2" Reflective	65.00	
Platinum	H-PR-1 10 lbs	Yes	1/2" Reflective	65.00	
Gunmetal	H-GR-1 10 lbs	Yes	1/2" Reflective	65.00	
Sapphire	H-SR-1 10 lbs	Yes	1/2" Reflective	65.00	
Blue Lagoon	H-BLR-1 10 lbs	Yes	1/2" Reflective	65.00	
Caribbean Blue	H-CBR-1 10 lbs	Yes	1/2" Reflective	65.00	
Goldrush	H-GRR-1 10 lbs	Yes	1/2" Reflective	65.00	





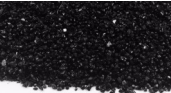





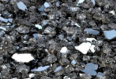

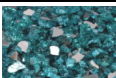

Lava and Sand

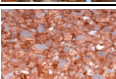





Black Sand	FGP-BS-10 10 lbs	Yes		20.00	
Black Lava	FGP-OL-S-10 10 lbs	Yes	3/8-in	20.00	
Black Lava	FGP-OL-M-10 10 lbs	Yes	1-in	20.00	

Fireglass +

Color	Item #	Stocked	Style	MAP	
Crystal Ice	Q-CI-1	Yes	1/4"	55.00	
Bronze	Q-BR-1 10 lbs	Yes	1/4" Reflective	55.00	
Gunmetal	Q-GR-1 10 lbs	Yes	1/4" Reflective	55.00	
Goldrush	Q-GRR-1 10 lbs	Yes	1/4" Reflective	57.50	
Blue Lagoon	Q-BLR-1 10 lbs	Yes	1/4" Reflective	55.00	
Caribbean Blue	Q-CBR-1 10 lbs	Yes	1/4" Reflective	55.00	
Copper	Q-CR-1 10 lbs	Yes	1/4" Reflective	55.00	
Rosegold	Q-RGR-1 10 lbs	Yes	1/4" Reflective	55.00	
Platinum	Q-PR-1 10 lbs	Yes	1/4" Reflective	55.00	
Emerald	Q-ER-1 10 lbs	Yes	1/4" Reflective	55.00	
Midnight Black	Q-MBR-1 10 lbs	Yes	1/4" Reflective	57.50	
Jade	Q-JR-1 10 lbs	Yes	1/4" Reflective	55.00	
Sapphire	Q-SR-1 10 lbs	Yes	1/4" Reflective	55.00	

Blended Glass

Color	Item #	Stocked	Style	MAP	
Bermuda Blend	Q-BB-1 10 lbs	Yes	1/4" Blend	57.50	
Outlaw Blend	Q-OB-1 10 lbs	Yes	1/4" Blend	57.50	
Sedona Blend	Q-SB-1 10 lbs	Yes	1/4" Blend	57.50	
Shamrock Blend	Q-SHB-1 10 lbs	Yes	1/4" Blend	57.50	

Bulk Keys

Size	Item #	Stocked	MSRP	
3" Antique Copper	NKY.3.AC.B	Yes	9.99	
3" Bright Copper	NKY.3.BC.B	Yes	9.99	
3" Flat Black	NKY.3.FB.B	Yes	9.99	
3" Pewter	NKY.3.PTR.B	Yes	9.99	
3" Satin Nickel	NKY.3.SN.B	Yes	9.99	
12" Brass	NKY.12.BR.B	Yes	18.99	
12" Chrome	NKY.12.CR.B	Yes	18.99	
18" Brass	NKY.18.BR.B	Yes	21.99	
18" Chrome	NKY.18.CR.B	Yes	21.99	
24" Brass	NKY.24.BR.B	Yes	24.99	
24" Chrome	NKY.24.CR.B	Yes	24.99	

Carded Keys

Size	Item #	Stocked	MSRP	
3" Carded Brass	NKY.3.BR	Yes	9.99	
3" Carded Chrome	NKY.3.CR	Yes	9.99	
8" Carded Brass	NKY.8.BR	Yes	14.99	
8" Carded Chrome	NKY.8.CR	Yes	14.99	

Floor Plates

Valve Style	Item #	Stocked	MSRP	
Antique Copper	FP.GV.AC	Yes	11.99	<p>The mating valve thread for Dante Products floor plates is 1/2" -14 NPSM.</p>
Bright Copper	FP.GV.BC	Yes	11.99	
Brass	FP.GV.BR	Yes	10.99	
Chrome	FP.GV.CR	Yes	10.99	
Flat Black	FP.GV.FB	Yes	11.99	
Plain	FP.GV.PLN	Yes	10.99	
Pewter	FP.GV.PTR	Yes	11.99	
Satin Nickel	FP.GV.SN	Yes	11.99	

Floor Plate Rings Available as a non-stock basis

	Item #	Stocked	MSRP	
Universal Mixer LP	711.U.UP	Yes	19.99	
Universal Mixer NG	711.U.NG	Yes	19.99	
Burner Pipe Standard or Stainless Steel	712	Yes	9.99	
	717	Yes	10.99	
	717SS	Yes	21.99	
	724	Yes	17.99	
	724SS	Yes	32.99	
	730	Yes	22.99	
	730SS	Yes	39.99	
	736	Yes	27.99	
	736SS	Yes	44.99	
742	Yes	29.99		

Carded Combo Packs

Style	Item #	Stocked	MSRP	
Angled ball valve, 3" brass key and floor plate	CP.BVA.BR	Yes	29.99	
Angled ball valve, 3" chrome key and floor plate	CP.BVA.CR	Yes	29.99	
Straight ball valve, 3" brass key and floor plate	CP.BVS.BR	Yes	29.99	
Straight ball valve, 3" chrome key and floor plate	CP.BVS.CR	Yes	29.99	

Gas Valves

Style	Item #	Stocked	MSRP	
Angled 1/2" 1/4-turn ball valve	BVA 98,000 BTU	Yes	20.99	
Straight 1/2" 1/4-turn ball valve	BVS 158,000 BTU	Yes	20.99	
Straight 3/4" 1/4-turn ball valve	BVS2 300,000 BTU	Yes	29.99	



SuperFlex™ Stainless Steel Liner Kits









Diameter	Item #	Stocked	Installed	
SLKC Series ~ WOOD INSERT APPLICATION				
Includes: Specified Length of Stainless Steel Flex, Vent Cap, Integrated Top Plate/Storm Collar, Connector, Instructions Features: Built with Tough and Flexible 316L Stainless Steel, Removable Snout Tee for Ease of Install, 5" through 8" Diameters, 25' and 35' Lengths				
6" add \$400 to price if not our insert	SLK0625C 6" D x 25' L	Yes	864.37	
	SLK0635C 6" D x 35' L	Yes	1129.80	
SLKT Series				
Includes: Specified Length of Stainless Steel Flex, Vent Cap, Top Plate, Storm Collar, Instructions Features: Built with Tough and Flexible 316L Stainless Steel, Removable Snout Tee for Ease of Install, 3" and 4" Diameters, 25' and 35' Lengths				
3"	SLK0325T 3" D x 25' L	Yes	1373.50	
	SLK0335T 3" D x 35' L	Yes	1499.00	
4"	SLK0425T 4" D x 25' L	Yes	1408.50	
	SLK0435T 4" D x 35' L	Yes	1499.00	
SLKT Series				
Includes: Specified Length of Stainless Steel Flex, Vent Cap, Top Plate, Tee, Instructions Features: Built with Tough and Flexible 316L Stainless Steel, Removable Snout Tee for Ease of Install, 5" and 8" Diameters, 25' and 35' Lengths				
5"	SLK0525T 5" D x 25' L	Yes	1561.17	
	SLK0535T 5" D x 35' L	Yes	1652.33	
6"	SLK0625T 6" D x 25' L	Yes	1712.01	
	SLK0635T 6" D x 35' L	Yes	1825.96	
7"	SLK0725T 7" D x 25' L	Yes	1911.94	
	SLK0735T 7" D x 35' L	Yes	2078.50	
8"	SLK0825T 8" D x 25' L	Yes	2082.07	
	SLK0835T 8" D x 35' L	Yes	2245.11	

In-Stock Items Available within 24 hours or can be picked up from our warehouse!
 Non-Stock items normally available within 7-10 Business Days
 Additional Items Available ~ Check Manufacturer Pricelists

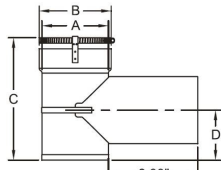

SuperFlex™ Stainless Steel Components

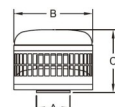

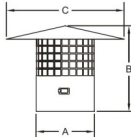





	Item #	Stocked	Retail																																				
Coiled Flex ~ 1-foot increment																																							
3" dia	SLX0335-01	Yes	48.00																																				
4" dia	SLX0435-01	Yes	56.00																																				
5" dia	SLX0535-01	Yes	61.00																																				
6" dia	SLX0635-01	Yes	64.00																																				
7" dia	SLX0735-01	Yes	66.00																																				
8" dia	SLX0835-01	Yes	68.00																																				
Tee																																							
3" dia	3SLT	Yes	159.01	  <table border="1" data-bbox="1230 1138 1539 1291"> <thead> <tr> <th>CAT. NO.</th> <th>A</th> <th>B</th> <th>C</th> <th>D</th> </tr> </thead> <tbody> <tr> <td>3SLT</td> <td>3.00</td> <td>3.50</td> <td>9.13</td> <td>3.25</td> </tr> <tr> <td>4SLT</td> <td>4.00</td> <td>4.50</td> <td>10.13</td> <td>3.75</td> </tr> <tr> <td>5SLT</td> <td>5.00</td> <td>5.50</td> <td>11.13</td> <td>4.25</td> </tr> <tr> <td>6SLT</td> <td>6.00</td> <td>6.50</td> <td>12.13</td> <td>4.75</td> </tr> <tr> <td>7SLT</td> <td>7.00</td> <td>7.50</td> <td>13.13</td> <td>5.25</td> </tr> <tr> <td>8SLT</td> <td>8.00</td> <td>8.50</td> <td>14.13</td> <td>5.75</td> </tr> </tbody> </table>	CAT. NO.	A	B	C	D	3SLT	3.00	3.50	9.13	3.25	4SLT	4.00	4.50	10.13	3.75	5SLT	5.00	5.50	11.13	4.25	6SLT	6.00	6.50	12.13	4.75	7SLT	7.00	7.50	13.13	5.25	8SLT	8.00	8.50	14.13	5.75
CAT. NO.	A	B	C		D																																		
3SLT	3.00	3.50	9.13		3.25																																		
4SLT	4.00	4.50	10.13		3.75																																		
5SLT	5.00	5.50	11.13		4.25																																		
6SLT	6.00	6.50	12.13		4.75																																		
7SLT	7.00	7.50	13.13	5.25																																			
8SLT	8.00	8.50	14.13	5.75																																			
4" dia	4SLT	Yes	163.24																																				
5" dia	5SLT	Yes	168.08																																				
6" dia	6SLT	Yes	172.86																																				
7" dia	7SLT	Yes	190.15																																				
8" dia	8SLT	Yes	197.37																																				
Caps																																							
3" dia	3PRC	Yes	126.09	  <table border="1" data-bbox="1253 1480 1507 1543"> <thead> <tr> <th>CAT. NO.</th> <th>A</th> <th>B</th> <th>C</th> </tr> </thead> <tbody> <tr> <td>3PRC</td> <td>3.00</td> <td>8.25</td> <td>6.75</td> </tr> <tr> <td>4PRC</td> <td>4.00</td> <td>8.25</td> <td>6.75</td> </tr> </tbody> </table>	CAT. NO.	A	B	C	3PRC	3.00	8.25	6.75	4PRC	4.00	8.25	6.75																							
CAT. NO.	A	B	C																																				
3PRC	3.00	8.25	6.75																																				
4PRC	4.00	8.25	6.75																																				
4" dia	4PRC	Yes	129.76																																				
5" dia	5SLC	Yes	162.91	  <table border="1" data-bbox="1250 1696 1518 1806"> <thead> <tr> <th>CAT. NO.</th> <th>A</th> <th>B</th> <th>C</th> </tr> </thead> <tbody> <tr> <td>5SLC</td> <td>6.00</td> <td>9.75</td> <td>12.50</td> </tr> <tr> <td>6SLC</td> <td>7.00</td> <td>9.75</td> <td>13.50</td> </tr> <tr> <td>7SLC</td> <td>8.00</td> <td>10.00</td> <td>14.50</td> </tr> <tr> <td>8SLC</td> <td>9.00</td> <td>10.00</td> <td>15.50</td> </tr> </tbody> </table>	CAT. NO.	A	B	C	5SLC	6.00	9.75	12.50	6SLC	7.00	9.75	13.50	7SLC	8.00	10.00	14.50	8SLC	9.00	10.00	15.50															
CAT. NO.	A	B	C																																				
5SLC	6.00	9.75	12.50																																				
6SLC	7.00	9.75	13.50																																				
7SLC	8.00	10.00	14.50																																				
8SLC	9.00	10.00	15.50																																				
6" dia	6SLC	Yes	165.31																																				
7" dia	7SLC	Yes	171.06																																				
8" dia	8SLC	Yes	175.42																																				

In-Stock Items Available within 24 hours or can be picked up from our warehouse!
Non-Stock items normally available within 7-10 Business Days
Additional Items Available ~ Check Manufacturer Pricelists

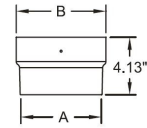

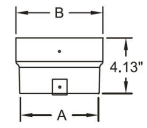
SuperFlex™ Stainless Steel Components

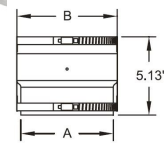

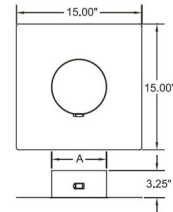
	Item #	Stocked	Retail																						
Flex Connector Standard	3SLFC 3"	Yes	48.00	  <table border="1" data-bbox="1307 556 1550 766"> <thead> <tr> <th>CAT. NO.</th> <th>A</th> <th>B</th> </tr> </thead> <tbody> <tr><td>3SLFC</td><td>3.00</td><td>3.50</td></tr> <tr><td>4SLFC</td><td>4.00</td><td>4.50</td></tr> <tr><td>5SLFC</td><td>5.00</td><td>5.50</td></tr> <tr><td>6SLFC</td><td>6.00</td><td>6.50</td></tr> <tr><td>7SLFC</td><td>7.00</td><td>7.50</td></tr> <tr><td>8SLFC</td><td>8.00</td><td>8.50</td></tr> </tbody> </table>	CAT. NO.	A	B	3SLFC	3.00	3.50	4SLFC	4.00	4.50	5SLFC	5.00	5.50	6SLFC	6.00	6.50	7SLFC	7.00	7.50	8SLFC	8.00	8.50
	CAT. NO.	A	B																						
	3SLFC	3.00	3.50																						
	4SLFC	4.00	4.50																						
	5SLFC	5.00	5.50																						
	6SLFC	6.00	6.50																						
7SLFC	7.00	7.50																							
8SLFC	8.00	8.50																							
4SLFC 4"	Yes	52.00																							
5SLFC 5"	Yes	56.00																							
6SLFC 6"	Yes	60.00																							
7SLFC 7"	Yes	66.00																							
8SLFC 8"	Yes	72.00																							
Flex Connector Standard with Pull Bar	3SLFCP 3"	Yes	56.00	  <table border="1" data-bbox="1299 955 1550 1144"> <thead> <tr> <th>CAT. NO.</th> <th>A</th> <th>B</th> </tr> </thead> <tbody> <tr><td>3SLFCP</td><td>3.00</td><td>3.50</td></tr> <tr><td>4SLFCP</td><td>4.00</td><td>4.50</td></tr> <tr><td>5SLFCP</td><td>5.00</td><td>5.50</td></tr> <tr><td>6SLFCP</td><td>6.00</td><td>6.50</td></tr> <tr><td>7SLFCP</td><td>7.00</td><td>7.50</td></tr> <tr><td>8SLFCP</td><td>8.00</td><td>8.50</td></tr> </tbody> </table>	CAT. NO.	A	B	3SLFCP	3.00	3.50	4SLFCP	4.00	4.50	5SLFCP	5.00	5.50	6SLFCP	6.00	6.50	7SLFCP	7.00	7.50	8SLFCP	8.00	8.50
	CAT. NO.	A	B																						
	3SLFCP	3.00	3.50																						
	4SLFCP	4.00	4.50																						
	5SLFCP	5.00	5.50																						
	6SLFCP	6.00	6.50																						
7SLFCP	7.00	7.50																							
8SLFCP	8.00	8.50																							
4SLFCP 4"	Yes	63.00																							
5SLFCP 5"	Yes	75.00																							
6SLFCP 6"	Yes	80.00																							
7SLFCP 7"	Yes	87.00																							
8SLFCP 8"	Yes	94.00																							
Flex Connector Standard with Clamp Connector	3SLFCC 3"	Yes	107.00	  <table border="1" data-bbox="1299 1333 1550 1522"> <thead> <tr> <th>CAT. NO.</th> <th>A</th> <th>B</th> </tr> </thead> <tbody> <tr><td>3SLFCC</td><td>3.00</td><td>3.50</td></tr> <tr><td>4SLFCC</td><td>4.00</td><td>4.50</td></tr> <tr><td>5SLFCC</td><td>5.00</td><td>5.50</td></tr> <tr><td>6SLFCC</td><td>6.00</td><td>6.50</td></tr> <tr><td>7SLFCC</td><td>7.00</td><td>7.50</td></tr> <tr><td>8SLFCC</td><td>8.00</td><td>8.50</td></tr> </tbody> </table>	CAT. NO.	A	B	3SLFCC	3.00	3.50	4SLFCC	4.00	4.50	5SLFCC	5.00	5.50	6SLFCC	6.00	6.50	7SLFCC	7.00	7.50	8SLFCC	8.00	8.50
	CAT. NO.	A	B																						
	3SLFCC	3.00	3.50																						
	4SLFCC	4.00	4.50																						
	5SLFCC	5.00	5.50																						
	6SLFCC	6.00	6.50																						
7SLFCC	7.00	7.50																							
8SLFCC	8.00	8.50																							
4SLFCC 4"	Yes	113.00																							
5SLFCC 5"	Yes	115.00																							
6SLFCC 6"	Yes	121.00																							
7SLFCC 7"	Yes	144.00																							
8SLFCC 8"	Yes	149.00																							
Top Plate	3SLTP 3"	Yes	110.00	  <table border="1" data-bbox="1323 1648 1550 1879"> <thead> <tr> <th>CAT. NO.</th> <th>A</th> </tr> </thead> <tbody> <tr><td>3SLTP</td><td>3.50</td></tr> <tr><td>4SLTP</td><td>4.50</td></tr> <tr><td>5SLTP</td><td>5.50</td></tr> <tr><td>6SLTP</td><td>6.50</td></tr> <tr><td>7SLTP</td><td>7.50</td></tr> <tr><td>8SLTP</td><td>8.50</td></tr> </tbody> </table>	CAT. NO.	A	3SLTP	3.50	4SLTP	4.50	5SLTP	5.50	6SLTP	6.50	7SLTP	7.50	8SLTP	8.50							
	CAT. NO.	A																							
	3SLTP	3.50																							
	4SLTP	4.50																							
	5SLTP	5.50																							
	6SLTP	6.50																							
7SLTP	7.50																								
8SLTP	8.50																								
4SLTP 4"	Yes	114.00																							
5SLTP 5"	Yes	117.00																							
6SLTP 6"	Yes	120.00																							
7SLTP 7"	Yes	132.00																							
8SLTP 8"	Yes	136.00																							

In-Stock Items Available within 24 hours or can be picked up from our warehouse!
 Non-Stock items normally available within 7-10 Business Days
 Additional Items Available ~ Check Manufacturer Pricelists

Flexible Pipe Sizing Guide

Capacity of Flexible Pipe / Serving a Single Category 1 Appliance (Derated 20% from B-Vent Tables)

Height "H"	Connector Options "C"	Lateral "L"	FLEX PIPE DIAMETER – "D" (inches)																	
			3"			4"			5"			5.5"			6"			7"		
			Appliance INPUT Rating in Thousands of BTU per Hour																	
			FAN Min	FAN Max	NAT Max	FAN Min	FAN Max	NAT Max	FAN Min	FAN Max	NAT Max	FAN Min	FAN Max	NAT Max	FAN Min	FAN Max	NAT Max	FAN Min	FAN Max	NAT Max
15'	Type B	5'	22	52	36	30	104	70	39	175	114	40	202	132	49	264	174	64	370	240
	Single Wall	10'	29	47	33	40	97	66	51	165	108	53	192	126	64	252	166	84	356	230
25'	Type B	5'	21	60	41	29	121	82	37	207	135	38	241	157	46	316	206	60	448	289
	Single Wall	10'	28	54	38	38	113	77	49	197	129	51	230	150	61	303	196	79	432	277
30'	Type B	5'	21	62	43	28	128	86	36	220	141	37	256	165	45	337	218	58	480	308
	Single Wall	10'	27	56	40	37	120	82	48	210	137	49	246	159	59	324	209	77	464	297
35'	Type B	5'	21	63	32	28	132	88	36	228	146	37	266	171	45	350	225	57	501	319
	Single Wall	10'	27	57	30	37	124	84	47	217	141	48	255	164	58	337	216	76	484	308
45'	Type B	5'	21	65	*	28	139	93	36	243	156	37	285	182	44	377	239	57	542	340
	Single Wall	10'	27	60	*	36	131	89	47	232	149	48	274	175	58	364	231	75	525	330
	Type B	5'	49	60	*	72	129	87	97	224	143	107	263	169	135	347	224	169	496	317
	Single Wall	10'	*	*	*	91	118	83	121	212	138	133	250	161	169	331	213	211	476	305
	Type B	5'	21	65	*	28	139	93	36	243	156	37	285	182	44	377	239	57	542	340
	Single Wall	10'	27	60	*	36	131	89	47	232	149	48	274	175	58	364	231	75	525	330
	Type B	5'	49	63	*	71	136	92	96	239	153	106	282	180	134	373	238	168	537	338
	Single Wall	10'	*	*	*	90	125	*	120	227	146	132	268	172	167	356	227	208	517	326

*Not Recommended

Common Vent Capacity of Flexible Pipe / Serving Two or More Category 1 Appliances (Derated 20% from B-Vent Tables)

Height "H"	Connector Options "C"	FLEX PIPE COMMON VENT DIAMETER – "D" (inches)																	
		4"		5"		5.5"		6"		7"		8"							
		Combined Appliance INPUT Rating in Thousands of BTU per Hour																	
		FAN +FAN	FAN +NAT	NAT NAT	FAN +FAN	FAN +NAT	NAT NAT	FAN +FAN	FAN +NAT	NAT NAT	FAN +FAN	FAN +NAT	NAT NAT	FAN +FAN	FAN +NAT	NAT NAT	FAN +FAN	FAN +NAT	NAT NAT
15'	Type B	100	90	73	156	131	115	182	149	133	227	182	165	342	282	224	445	355	292
	Single Wall	97	86	70	151	127	112	176	144	129	220	177	160	333	274	219	435	347	286
25'	Type B	116	104	88	184	157	138	216	180	160	270	221	198	409	341	268	537	434	350
	Single Wall	111	100	84	178	152	134	209	174	155	262	214	192	398	332	261	524	423	342
30'	Type B	122	110	94	195	168	148	230	193	171	289	238	213	438	367	288	576	468	376
	Single Wall	116	106	90	189	162	143	223	186	166	280	229	206	426	357	279	562	456	367
35'	Type B	125	113	98	202	175	154	239	201	179	301	249	222	457	385	300	603	492	392
	Single Wall	119	109	93	195	168	148	231	193	172	291	239	214	444	374	291	588	479	382
45'	Type B	151	119	104	216	189	166	257	219	193	325	271	240	494	420	326	656	541	424
	Single Wall	125	114	99	208	180	158	248	209	184	314	260	229	480	407	316	640	526	413

*Not Recommended

D = Flex Diameter
(common vent)
C = Connector
H = Height
L = Lateral

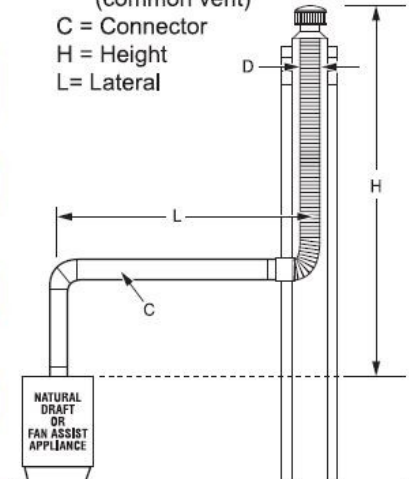

D = Flex Diameter
(common vent)
C = Connector
H = Height
L = Lateral

L shall be less than or equal to 1.5 feet x D.

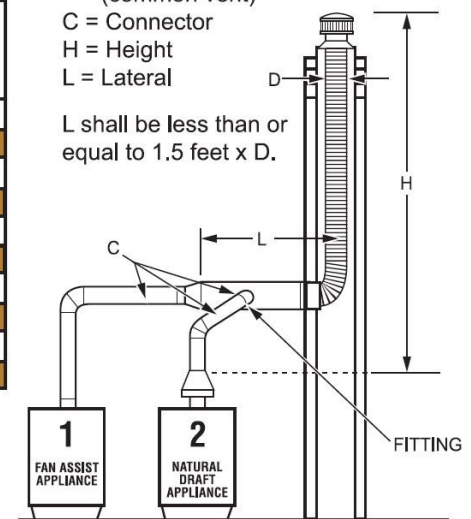

In-Stock Items Available within 24 hours or can be picked up from our warehouse!
Non-Stock items normally available within 7-10 Business Days
Additional Items Available ~ Check Manufacturer Pricelists



Aluminum Complete Liner Kits



MLK Series Premium Liner Kit	Size	Item #	Stocked	Kit Includes
 	3" D x 25' L	MLK0325	Yes	<ul style="list-style-type: none"> • Specified Length of 2-ply Aluminum Flex • Vent Cap • Storm Collar • Heavy Gauge Galvanized Flashing • Mortar Guard with Tag • Instructions <p>Features</p> <ul style="list-style-type: none"> • Quick Connect Couplings Pre-attached to Both Ends (no leader core required) • Throw-away Pull Bar Twist-locks to Rigid B-Vent Extension in Straight-away of Masonry Chimney
	3" D x 35' L	MLK0335	Yes	
	4" D x 25' L	MLK0425	Yes	
	4" D x 35' L	MLK0435	Yes	
	5" D x 25' L	MLK0525	Yes	
	5" D x 35' L	MLK0535	Yes	
	6" D x 25' L	MLK0625	Yes	
	6" D x 35' L	MLK0635	Yes	
	7" D x 25' L	MLK0725	Yes	
	7" D x 35' L	MLK0735	Yes	
	8" D x 25' L	MLK0825	Yes	
	8" D x 35' L	MLK0835	Yes	

See Pricing on Opposite Page

In-Stock Items Available within 24 hours or can be picked up from our warehouse!
Non-Stock items normally available within 7-10 Business Days
Additional Items Available ~ Check Manufacturer Pricelists



Aluminum Complete Liner Kits



MLK Series Premium Liner Kit	Size	Item #	Retail
	3" D x 25' L	MLK0325	572.98
	3" D x 35' L	MLK0335	632.52
	4" D x 25' L	MLK0425	632.17
	4" D x 35' L	MLK0435	699.00
	5" D x 25' L	MLK0525	699.00
	5" D x 35' L	MLK0535	799.00
	6" D x 25' L	MLK0625	799.00
	6" D x 35' L	MLK0635	899.00
	7" D x 25' L	MLK0725	899.00
	7" D x 35' L	MLK0735	999.00
	8" D x 25' L	MLK0825	999.00
	8" D x 35' L	MLK0835	1099.00









Flexible Aluminum Connectors

Features: 2-ply Aluminum Flex, Twist Lock B-Vent Male Connection, Stainless Steel Single Wall Connection, Eliminates the need to cut-crimp-screw fasten sections of rigid single wall connector, MLCK connector is UL listed

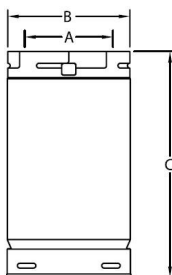
Diameter	Item #	Stocked	MSRP	
3"	MLCK0305 Up to 5' Expandable	Yes	63.00	
4"	MLCK0405 Up to 5' Expandable	Yes	71.00	
5"	MLCK0505 Up to 5' Expandable	Yes	79.00	
6"	MLCK0605 Up to 5' Expandable	Yes	86.00	

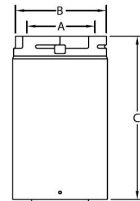
Direct Vent Products 4" I.D.

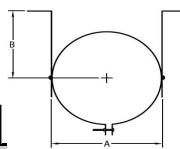

		Item #	Stocked	Retail																													
Straight Length Assembly																																	
Standard 4" I.D. 6.5" O.D.	6"	4D6	Yes	24.58	  <table border="1" style="margin-top: 10px;"> <thead> <tr> <th>CAT. NO.</th> <th>A</th> <th>B</th> <th>C</th> </tr> </thead> <tbody> <tr> <td>4D6</td> <td>4.00"</td> <td>6.50"</td> <td>6.00"</td> </tr> <tr> <td>4D12</td> <td>4.00"</td> <td>6.50"</td> <td>12.00"</td> </tr> <tr> <td>4D18</td> <td>4.00"</td> <td>6.50"</td> <td>18.00"</td> </tr> <tr> <td>4D24</td> <td>4.00"</td> <td>6.50"</td> <td>24.00"</td> </tr> <tr> <td>4D36</td> <td>4.00"</td> <td>6.50"</td> <td>36.00"</td> </tr> <tr> <td>4D48</td> <td>4.00"</td> <td>6.50"</td> <td>48.00"</td> </tr> </tbody> </table>	CAT. NO.	A	B	C	4D6	4.00"	6.50"	6.00"	4D12	4.00"	6.50"	12.00"	4D18	4.00"	6.50"	18.00"	4D24	4.00"	6.50"	24.00"	4D36	4.00"	6.50"	36.00"	4D48	4.00"	6.50"	48.00"
	CAT. NO.	A	B	C																													
	4D6	4.00"	6.50"	6.00"																													
	4D12	4.00"	6.50"	12.00"																													
	4D18	4.00"	6.50"	18.00"																													
	4D24	4.00"	6.50"	24.00"																													
4D36	4.00"	6.50"	36.00"																														
4D48	4.00"	6.50"	48.00"																														
12"	4D12	Yes	32.72																														
18"	4D18	Yes	43.79																														
24"	4D24	Yes	47.68																														
36"	4D36	Yes	52.43																														
48"	4D48	Yes	62.67																														
Adjustable Length																																	
Standard 3" - 10"	4" I.D. 6.5" O.D. Adj Length	4DAL	Yes	41.39	  <table border="1" style="margin-top: 10px;"> <thead> <tr> <th>CAT. NO.</th> <th>A</th> <th>B</th> <th>C</th> <th>ADJUSTABLE RANGE</th> </tr> </thead> <tbody> <tr> <td>4DAL</td> <td>4.00"</td> <td>6.50"</td> <td>11.75"</td> <td>3.00" to 10.00"</td> </tr> </tbody> </table>	CAT. NO.	A	B	C	ADJUSTABLE RANGE	4DAL	4.00"	6.50"	11.75"	3.00" to 10.00"																		
CAT. NO.	A	B	C	ADJUSTABLE RANGE																													
4DAL	4.00"	6.50"	11.75"	3.00" to 10.00"																													
Wall Support																																	
Standard	4" I.D. 6.5" O.D.	4DWS	Yes	19.40	  <table border="1" style="margin-top: 10px;"> <thead> <tr> <th>CAT. NO.</th> <th>A</th> <th>B</th> </tr> </thead> <tbody> <tr> <td>4DWS</td> <td>6.63"</td> <td>4.72"</td> </tr> </tbody> </table>	CAT. NO.	A	B	4DWS	6.63"	4.72"																						
CAT. NO.	A	B																															
4DWS	6.63"	4.72"																															
Direct Vent Masonry Relining Kit																																	
<ul style="list-style-type: none"> • Designed for masonry relining • Intake & exhaust collars rotate 45° • One-piece unitized termination design • 3" and 4" tandem liners (4DVT43FK) or Dual 2-ply 3" (4DVT33FK) flexible aluminum liners • Intake & exhaust labeled on termination for convenience 	4DVT43FK	Yes	450.88	 																													
	4DVT33FK		395.30																														

Direct Vent Products 4" I.D.

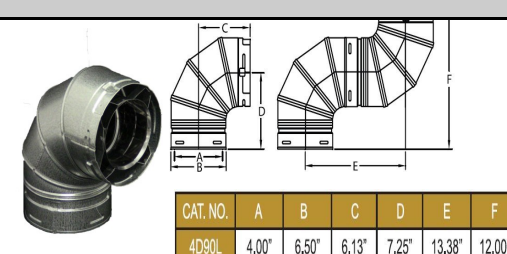
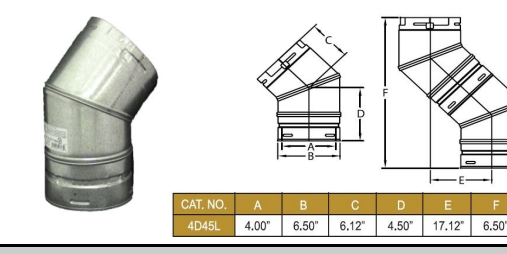
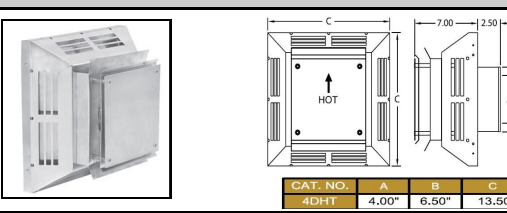
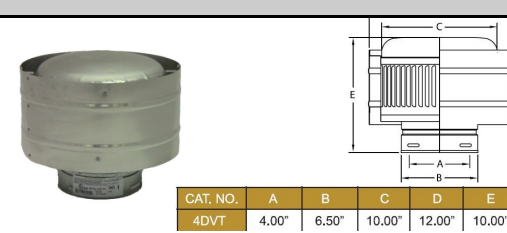
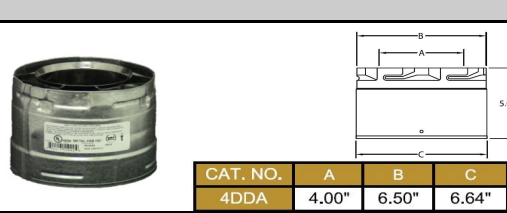
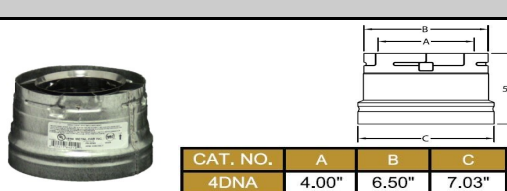

		Item #	Stocked	Retail															
90° Swivel Elbow																			
Standard	4" I.D. 6.5" O.D.	4D90L	Yes	62.67	 <table border="1" style="margin-top: 10px;"> <thead> <tr> <th>CAT. NO.</th> <th>A</th> <th>B</th> <th>C</th> <th>D</th> <th>E</th> <th>F</th> </tr> </thead> <tbody> <tr> <td>4D90L</td> <td>4.00"</td> <td>6.50"</td> <td>6.13"</td> <td>7.25"</td> <td>13.38"</td> <td>12.00"</td> </tr> </tbody> </table>	CAT. NO.	A	B	C	D	E	F	4D90L	4.00"	6.50"	6.13"	7.25"	13.38"	12.00"
CAT. NO.	A	B	C	D	E	F													
4D90L	4.00"	6.50"	6.13"	7.25"	13.38"	12.00"													
45° Swivel Elbow																			
Standard	4" I.D. 6.5" O.D.	4D45L	Yes	54.47	 <table border="1" style="margin-top: 10px;"> <thead> <tr> <th>CAT. NO.</th> <th>A</th> <th>B</th> <th>C</th> <th>D</th> <th>E</th> <th>F</th> </tr> </thead> <tbody> <tr> <td>4D45L</td> <td>4.00"</td> <td>6.50"</td> <td>6.12"</td> <td>4.50"</td> <td>17.12"</td> <td>6.50"</td> </tr> </tbody> </table>	CAT. NO.	A	B	C	D	E	F	4D45L	4.00"	6.50"	6.12"	4.50"	17.12"	6.50"
CAT. NO.	A	B	C	D	E	F													
4D45L	4.00"	6.50"	6.12"	4.50"	17.12"	6.50"													
Horizontal Termination																			
Standard	4" I.D. 6.5" O.D.	4DHT	Yes	182.19	 <table border="1" style="margin-top: 10px;"> <thead> <tr> <th>CAT. NO.</th> <th>A</th> <th>B</th> <th>C</th> </tr> </thead> <tbody> <tr> <td>4DHT</td> <td>4.00"</td> <td>6.50"</td> <td>13.50"</td> </tr> </tbody> </table>	CAT. NO.	A	B	C	4DHT	4.00"	6.50"	13.50"						
CAT. NO.	A	B	C																
4DHT	4.00"	6.50"	13.50"																
Vertical Termination - High Wind																			
Standard	4" I.D. 6.5" O.D.	4DVT	Yes	70.60	 <table border="1" style="margin-top: 10px;"> <thead> <tr> <th>CAT. NO.</th> <th>A</th> <th>B</th> <th>C</th> <th>D</th> <th>E</th> </tr> </thead> <tbody> <tr> <td>4DVT</td> <td>4.00"</td> <td>6.50"</td> <td>10.00"</td> <td>12.00"</td> <td>10.00"</td> </tr> </tbody> </table>	CAT. NO.	A	B	C	D	E	4DVT	4.00"	6.50"	10.00"	12.00"	10.00"		
CAT. NO.	A	B	C	D	E														
4DVT	4.00"	6.50"	10.00"	12.00"	10.00"														
Duravent Adapter																			
Standard	4" I.D. 6.5" O.D.	4DDA	Yes	29.14	 <table border="1" style="margin-top: 10px;"> <thead> <tr> <th>CAT. NO.</th> <th>A</th> <th>B</th> <th>C</th> </tr> </thead> <tbody> <tr> <td>4DDA</td> <td>4.00"</td> <td>6.50"</td> <td>6.64"</td> </tr> </tbody> </table>	CAT. NO.	A	B	C	4DDA	4.00"	6.50"	6.64"						
CAT. NO.	A	B	C																
4DDA	4.00"	6.50"	6.64"																
Napoleon Adapter																			
Standard	4" I.D. 6.5" O.D.	4DNA	Yes	30.01	 <table border="1" style="margin-top: 10px;"> <thead> <tr> <th>CAT. NO.</th> <th>A</th> <th>B</th> <th>C</th> </tr> </thead> <tbody> <tr> <td>4DNA</td> <td>4.00"</td> <td>6.50"</td> <td>7.03"</td> </tr> </tbody> </table>	CAT. NO.	A	B	C	4DNA	4.00"	6.50"	7.03"						
CAT. NO.	A	B	C																
4DNA	4.00"	6.50"	7.03"																

Direct Vent Products 4" I.D.



		Item #	Stocked	Retail																
Snorkel Termination																				
Standard 14" Offset On Center	4" I.D. 6.5" O.D.	4DST14	Yes	391.02	<table border="1" style="font-size: 8px; margin-top: 10px;"> <thead> <tr> <th>CAT. NO.</th> <th>A</th> <th>B</th> <th>C</th> <th>D</th> </tr> </thead> <tbody> <tr> <td>4DST14</td> <td>4.00"</td> <td>6.50"</td> <td>14.00"</td> <td>28.00"</td> </tr> <tr> <td>4DST36</td> <td>4.00"</td> <td>6.50"</td> <td>36.00"</td> <td>50.00"</td> </tr> </tbody> </table>	CAT. NO.	A	B	C	D	4DST14	4.00"	6.50"	14.00"	28.00"	4DST36	4.00"	6.50"	36.00"	50.00"
CAT. NO.	A	B	C	D																
4DST14	4.00"	6.50"	14.00"	28.00"																
4DST36	4.00"	6.50"	36.00"	50.00"																
Standard 36" Offset On Center	4" I.D. 6.5" O.D.	4DST36	Yes	472.14																
Flashing																				
Standard 1/12-5/12 Pitch	4" I.D. 6.5" O.D.	4DF	Yes	26.68	<table border="1" style="font-size: 8px; margin-top: 10px;"> <thead> <tr> <th>CAT. NO.</th> <th>A</th> <th>B</th> <th>PLATE SIZE</th> </tr> </thead> <tbody> <tr> <td>4DF</td> <td>6.75"</td> <td>9.50"</td> <td>17.50" x 17.50"</td> </tr> <tr> <td>4DF-12</td> <td>6.68"</td> <td>12.50"</td> <td>21.00" x 28.00"</td> </tr> </tbody> </table>	CAT. NO.	A	B	PLATE SIZE	4DF	6.75"	9.50"	17.50" x 17.50"	4DF-12	6.68"	12.50"	21.00" x 28.00"			
CAT. NO.	A	B	PLATE SIZE																	
4DF	6.75"	9.50"	17.50" x 17.50"																	
4DF-12	6.68"	12.50"	21.00" x 28.00"																	
Standard 6/12-12/12 Pitch	4" I.D. 6.5" O.D.	4DF-12	Yes	55.72																
Wall Thimble																				
Standard Adjustable from 3.25"-5.50"	4" I.D. 6.5" O.D.	4DWT	Yes	49.13	<table border="1" style="font-size: 8px; margin-top: 10px;"> <thead> <tr> <th>CAT. NO.</th> <th>A</th> <th>B</th> <th>C</th> </tr> </thead> <tbody> <tr> <td>4DWT</td> <td>8.69"</td> <td>11.00"</td> <td>4.00" x 6.50"</td> </tr> </tbody> </table>	CAT. NO.	A	B	C	4DWT	8.69"	11.00"	4.00" x 6.50"							
CAT. NO.	A	B	C																	
4DWT	8.69"	11.00"	4.00" x 6.50"																	
Storm Collar																				
Standard	4" I.D. 6.5" O.D.	4DSC	Yes	4.60	<table border="1" style="font-size: 8px; margin-top: 10px;"> <thead> <tr> <th>CAT. NO.</th> <th>A</th> </tr> </thead> <tbody> <tr> <td>4DSC</td> <td>6.54"</td> </tr> </tbody> </table>	CAT. NO.	A	4DSC	6.54"											
CAT. NO.	A																			
4DSC	6.54"																			
Firestop																				
Standard	4" I.D. 6.5" O.D.	4DFS	Yes	15.80	<table border="1" style="font-size: 8px; margin-top: 10px;"> <thead> <tr> <th>CAT. NO.</th> <th>A</th> <th>B</th> <th>C</th> </tr> </thead> <tbody> <tr> <td>4DFS</td> <td>6.56"</td> <td>8.50"</td> <td>10.50"</td> </tr> </tbody> </table>	CAT. NO.	A	B	C	4DFS	6.56"	8.50"	10.50"							
CAT. NO.	A	B	C																	
4DFS	6.56"	8.50"	10.50"																	
Vinyl Siding Stand Off																				
Standard	4" I.D. 6.5" O.D.	4DVS	Yes	71.79	<table border="1" style="font-size: 8px; margin-top: 10px;"> <thead> <tr> <th>CAT. NO.</th> <th>A</th> <th>B</th> <th>C</th> </tr> </thead> <tbody> <tr> <td>4DVS</td> <td>6.75"</td> <td>13.50"</td> <td>17.50"</td> </tr> </tbody> </table>	CAT. NO.	A	B	C	4DVS	6.75"	13.50"	17.50"							
CAT. NO.	A	B	C																	
4DVS	6.75"	13.50"	17.50"																	

www.FireplaceandChimneyAuthority.com









Direct Vent Products 5" I.D.

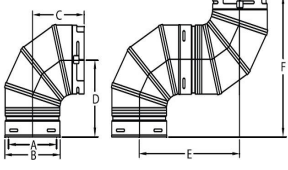

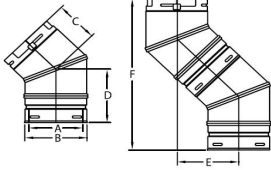
		Item #	Stocked	Retail																													
Straight Length Assembly																																	
Standard 5" I.D. 8" O.D.	6"	5D6	Yes	30.62	<table border="1" style="margin-top: 10px; font-size: 8px;"> <thead> <tr> <th>CAT. NO.</th> <th>A</th> <th>B</th> <th>C</th> </tr> </thead> <tbody> <tr> <td>5D6</td> <td>5.00"</td> <td>8.00"</td> <td>6.00"</td> </tr> <tr> <td>5D12</td> <td>5.00"</td> <td>8.00"</td> <td>12.00"</td> </tr> <tr> <td>5D18</td> <td>5.00"</td> <td>8.00"</td> <td>18.00"</td> </tr> <tr> <td>5D24</td> <td>5.00"</td> <td>8.00"</td> <td>24.00"</td> </tr> <tr> <td>5D36</td> <td>5.00"</td> <td>8.00"</td> <td>36.00"</td> </tr> <tr> <td>5D48</td> <td>5.00"</td> <td>8.00"</td> <td>48.00"</td> </tr> </tbody> </table>	CAT. NO.	A	B	C	5D6	5.00"	8.00"	6.00"	5D12	5.00"	8.00"	12.00"	5D18	5.00"	8.00"	18.00"	5D24	5.00"	8.00"	24.00"	5D36	5.00"	8.00"	36.00"	5D48	5.00"	8.00"	48.00"
	CAT. NO.	A	B	C																													
	5D6	5.00"	8.00"	6.00"																													
	5D12	5.00"	8.00"	12.00"																													
	5D18	5.00"	8.00"	18.00"																													
	5D24	5.00"	8.00"	24.00"																													
5D36	5.00"	8.00"	36.00"																														
5D48	5.00"	8.00"	48.00"																														
12"	5D12	Yes	35.89																														
18"	5D18	Yes	44.11																														
24"	5D24	Yes	47.16																														
36"	5D36	Yes	67.69																														
48"	5D48	Yes	85.58																														
Adjustable Length																																	
Standard 3" - 10" Expandable	5" I.D. 8" O.D. Adj Length	5DAL	Yes	43.52	<table border="1" style="margin-top: 10px; font-size: 8px;"> <thead> <tr> <th>CAT. NO.</th> <th>A</th> <th>B</th> <th>C</th> <th>ADJUSTABLE RANGE</th> </tr> </thead> <tbody> <tr> <td>5DAL</td> <td>5.00"</td> <td>8.00"</td> <td>11.75"</td> <td>3.00" to 10.00"</td> </tr> </tbody> </table>	CAT. NO.	A	B	C	ADJUSTABLE RANGE	5DAL	5.00"	8.00"	11.75"	3.00" to 10.00"																		
CAT. NO.	A	B	C	ADJUSTABLE RANGE																													
5DAL	5.00"	8.00"	11.75"	3.00" to 10.00"																													
Duravent Adapter																																	
Standard	5" I.D. 8" O.D.	5DDA	Yes	30.42	<table border="1" style="margin-top: 10px; font-size: 8px;"> <thead> <tr> <th>CAT. NO.</th> <th>A</th> <th>B</th> <th>C</th> </tr> </thead> <tbody> <tr> <td>5DDA</td> <td>5.00"</td> <td>8.00"</td> <td>8.01"</td> </tr> </tbody> </table>	CAT. NO.	A	B	C	5DDA	5.00"	8.00"	8.01"																				
CAT. NO.	A	B	C																														
5DDA	5.00"	8.00"	8.01"																														
Napoleon Adapter																																	
Standard	5" I.D. 8" O.D.	5DNA	Non-Stock	29.38	<table border="1" style="margin-top: 10px; font-size: 8px;"> <thead> <tr> <th>CAT. NO.</th> <th>A</th> <th>B</th> <th>C</th> </tr> </thead> <tbody> <tr> <td>5DNA</td> <td>5.00"</td> <td>8.00"</td> <td>8.01"</td> </tr> </tbody> </table>	CAT. NO.	A	B	C	5DNA	5.00"	8.00"	8.01"																				
CAT. NO.	A	B	C																														
5DNA	5.00"	8.00"	8.01"																														
Vinyl Siding Stand Off																																	
Standard	5" I.D. 8" O.D.	5DVS	Yes	74.38	<table border="1" style="margin-top: 10px; font-size: 8px;"> <thead> <tr> <th>CAT. NO.</th> <th>A</th> <th>B</th> <th>C</th> </tr> </thead> <tbody> <tr> <td>5DVS</td> <td>8.25"</td> <td>15.75"</td> <td>19.88"</td> </tr> </tbody> </table>	CAT. NO.	A	B	C	5DVS	8.25"	15.75"	19.88"																				
CAT. NO.	A	B	C																														
5DVS	8.25"	15.75"	19.88"																														

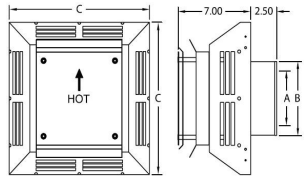
Direct Vent Products 5" I.D.

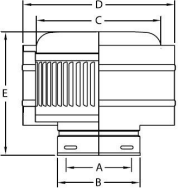

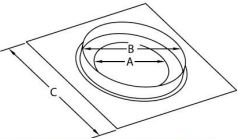
		Item #	Stocked	Retail															
90° Swivel Elbow																			
Standard	5" I.D. 8" O.D.	5D90L	Yes	78.11	  <table border="1" style="margin-top: 10px;"> <thead> <tr> <th>CAT. NO.</th> <th>A</th> <th>B</th> <th>C</th> <th>D</th> <th>E</th> <th>F</th> </tr> </thead> <tbody> <tr> <td>5D90L</td> <td>5.00"</td> <td>8.00"</td> <td>7.75"</td> <td>9.00"</td> <td>16.62"</td> <td>15.25"</td> </tr> </tbody> </table>	CAT. NO.	A	B	C	D	E	F	5D90L	5.00"	8.00"	7.75"	9.00"	16.62"	15.25"
CAT. NO.	A	B	C	D	E	F													
5D90L	5.00"	8.00"	7.75"	9.00"	16.62"	15.25"													
45° Swivel Elbow																			
Standard	5" I.D. 8" O.D.	5D45L	Yes	66.43	  <table border="1" style="margin-top: 10px;"> <thead> <tr> <th>CAT. NO.</th> <th>A</th> <th>B</th> <th>C</th> <th>D</th> <th>E</th> <th>F</th> </tr> </thead> <tbody> <tr> <td>5D45L</td> <td>5.00"</td> <td>8.00"</td> <td>5.25"</td> <td>4.50"</td> <td>15.62"</td> <td>5.93"</td> </tr> </tbody> </table>	CAT. NO.	A	B	C	D	E	F	5D45L	5.00"	8.00"	5.25"	4.50"	15.62"	5.93"
CAT. NO.	A	B	C	D	E	F													
5D45L	5.00"	8.00"	5.25"	4.50"	15.62"	5.93"													
Horizontal Termination																			
Standard	5" I.D. 8" O.D.	5DHT	Yes	222.57	  <table border="1" style="margin-top: 10px;"> <thead> <tr> <th>CAT. NO.</th> <th>A</th> <th>B</th> <th>C</th> </tr> </thead> <tbody> <tr> <td>5DHT</td> <td>5.00"</td> <td>8.00"</td> <td>16.00"</td> </tr> </tbody> </table>	CAT. NO.	A	B	C	5DHT	5.00"	8.00"	16.00"						
CAT. NO.	A	B	C																
5DHT	5.00"	8.00"	16.00"																
Vertical Termination - High Wind																			
Standard	5" I.D. 8" O.D.	5DVT	Yes	135.75	  <table border="1" style="margin-top: 10px;"> <thead> <tr> <th></th> <th>A</th> <th>B</th> <th>C</th> <th>D</th> <th>E</th> </tr> </thead> <tbody> <tr> <td>5DVT</td> <td>5.00"</td> <td>8.00"</td> <td>10.00"</td> <td>12.00"</td> <td>10.00"</td> </tr> </tbody> </table>		A	B	C	D	E	5DVT	5.00"	8.00"	10.00"	12.00"	10.00"		
	A	B	C	D	E														
5DVT	5.00"	8.00"	10.00"	12.00"	10.00"														
Firestop																			
Standard	5" I.D. 8" O.D.	5DFS	Yes	16.21	  <table border="1" style="margin-top: 10px;"> <thead> <tr> <th>CAT. NO.</th> <th>A</th> <th>B</th> <th>C</th> </tr> </thead> <tbody> <tr> <td>5DFS</td> <td>8.06"</td> <td>10.00"</td> <td>13.00"</td> </tr> </tbody> </table>	CAT. NO.	A	B	C	5DFS	8.06"	10.00"	13.00"						
CAT. NO.	A	B	C																
5DFS	8.06"	10.00"	13.00"																

www.FireplaceandChimneyAuthority.com

Direct Vent Products 5" I.D.









		Item #	Stocked	Retail																
Snorkel Termination																				
Standard 14" Offset On Center	5" I.D. 8" O.D.	5DST14	Yes	413.08	<table border="1" style="margin-top: 10px;"> <thead> <tr> <th>CAT NO.</th> <th>A</th> <th>B</th> <th>C</th> <th>D</th> </tr> </thead> <tbody> <tr> <td>5DST14</td> <td>5.00"</td> <td>8.00"</td> <td>14.00"</td> <td>28.00"</td> </tr> <tr> <td>5DST36</td> <td>5.00"</td> <td>8.00"</td> <td>36.00"</td> <td>50.00"</td> </tr> </tbody> </table>	CAT NO.	A	B	C	D	5DST14	5.00"	8.00"	14.00"	28.00"	5DST36	5.00"	8.00"	36.00"	50.00"
	CAT NO.	A	B	C		D														
5DST14	5.00"	8.00"	14.00"	28.00"																
5DST36	5.00"	8.00"	36.00"	50.00"																
Standard 36" Offset On Center	5" I.D. 8" O.D.	5DST36	Yes	490.40																
Flashing																				
Standard 1/12-5/12 Pitch	5" I.D. 8" O.D.	5DF	Yes	29.26	<table border="1" style="margin-top: 10px;"> <thead> <tr> <th>CAT NO.</th> <th>A</th> <th>B</th> <th>PLATE SIZE</th> </tr> </thead> <tbody> <tr> <td>5DF</td> <td>8.25"</td> <td>11.00"</td> <td>19.00" x 19.00"</td> </tr> <tr> <td>5DF-12</td> <td>5.00"</td> <td>8.00"</td> <td>21.00" x 28.00"</td> </tr> </tbody> </table>	CAT NO.	A	B	PLATE SIZE	5DF	8.25"	11.00"	19.00" x 19.00"	5DF-12	5.00"	8.00"	21.00" x 28.00"			
CAT NO.	A	B	PLATE SIZE																	
5DF	8.25"	11.00"	19.00" x 19.00"																	
5DF-12	5.00"	8.00"	21.00" x 28.00"																	
Standard 6/12-12/12 Pitch	5" I.D. 8" O.D.	5DF-12	Yes	101.56																
Wall Thimble																				
Standard Adjustable from 3.25"-5.50"	5" I.D. 8" O.D.	5DWT	Yes	50.00	<table border="1" style="margin-top: 10px;"> <thead> <tr> <th>CAT NO.</th> <th>A</th> <th>B</th> <th>C</th> </tr> </thead> <tbody> <tr> <td>5DWT</td> <td>10.18"</td> <td>13.25"</td> <td>4.00" x 6.50"</td> </tr> </tbody> </table>	CAT NO.	A	B	C	5DWT	10.18"	13.25"	4.00" x 6.50"							
CAT NO.	A	B	C																	
5DWT	10.18"	13.25"	4.00" x 6.50"																	
Storm Collar																				
Standard	5" I.D. 8" O.D.	5DSC	Yes	5.62	<table border="1" style="margin-top: 10px;"> <thead> <tr> <th>CAT NO.</th> <th>A</th> </tr> </thead> <tbody> <tr> <td>5DSC</td> <td>8.03"</td> </tr> </tbody> </table>	CAT NO.	A	5DSC	8.03"											
CAT NO.	A																			
5DSC	8.03"																			
Wall Support																				
Standard	5" I.D. 8" O.D.	5DWS	Yes	17.35	<table border="1" style="margin-top: 10px;"> <thead> <tr> <th>CAT NO.</th> <th>A</th> <th>B</th> </tr> </thead> <tbody> <tr> <td>5DWS</td> <td>8.06"</td> <td>5.06"</td> </tr> </tbody> </table>	CAT NO.	A	B	5DWS	8.06"	5.06"									
CAT NO.	A	B																		
5DWS	8.06"	5.06"																		

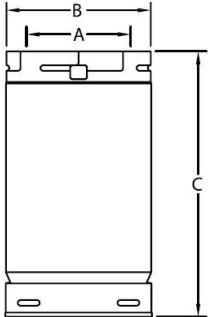

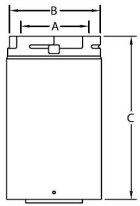
Direct Vent Products 4" I.D. - BLACK

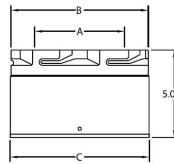

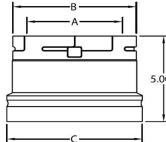
		Item #	Stocked	Retail																													
Straight Length Assembly																																	
Black 4" I.D. 6.5" O.D.	6"	4D6B	Yes	42.60	 <div style="display: flex; justify-content: space-around; align-items: center;">  <table border="1" style="font-size: 8px; border-collapse: collapse;"> <thead> <tr> <th>CAT. NO.</th> <th>A</th> <th>B</th> <th>C</th> </tr> </thead> <tbody> <tr> <td>4D6</td> <td>4.00"</td> <td>6.50"</td> <td>6.00"</td> </tr> <tr> <td>4D12</td> <td>4.00"</td> <td>6.50"</td> <td>12.00"</td> </tr> <tr> <td>4D18</td> <td>4.00"</td> <td>6.50"</td> <td>18.00"</td> </tr> <tr> <td>4D24</td> <td>4.00"</td> <td>6.50"</td> <td>24.00"</td> </tr> <tr> <td>4D36</td> <td>4.00"</td> <td>6.50"</td> <td>36.00"</td> </tr> <tr> <td>4D48</td> <td>4.00"</td> <td>6.50"</td> <td>48.00"</td> </tr> </tbody> </table> </div>	CAT. NO.	A	B	C	4D6	4.00"	6.50"	6.00"	4D12	4.00"	6.50"	12.00"	4D18	4.00"	6.50"	18.00"	4D24	4.00"	6.50"	24.00"	4D36	4.00"	6.50"	36.00"	4D48	4.00"	6.50"	48.00"
	CAT. NO.	A	B	C																													
	4D6	4.00"	6.50"	6.00"																													
	4D12	4.00"	6.50"	12.00"																													
	4D18	4.00"	6.50"	18.00"																													
	4D24	4.00"	6.50"	24.00"																													
4D36	4.00"	6.50"	36.00"																														
4D48	4.00"	6.50"	48.00"																														
12"	4D12B	Yes	49.70																														
18"	4D18B	Yes	58.60																														
24"	4D24B	Yes	61.51																														
36"	4D36B	Yes	78.50																														
48"	4D48B	Yes	95.39																														
Adjustable Length																																	
Black 3" - 10"	4" I.D. 6.5" O.D. Adj Length	4DALB	Yes	50.33	 <div style="display: flex; justify-content: space-around; align-items: center;">  <table border="1" style="font-size: 8px; border-collapse: collapse;"> <thead> <tr> <th>CAT. NO.</th> <th>A</th> <th>B</th> <th>C</th> <th>ADJUSTABLE RANGE</th> </tr> </thead> <tbody> <tr> <td>4DAL</td> <td>4.00"</td> <td>6.50"</td> <td>11.75"</td> <td>3.00" to 10.00"</td> </tr> </tbody> </table> </div>	CAT. NO.	A	B	C	ADJUSTABLE RANGE	4DAL	4.00"	6.50"	11.75"	3.00" to 10.00"																		
CAT. NO.	A	B	C	ADJUSTABLE RANGE																													
4DAL	4.00"	6.50"	11.75"	3.00" to 10.00"																													
Duravent Adapter																																	
Black	4" I.D. 6.5" O.D.	4DDAB	Yes	34.43	 <div style="display: flex; justify-content: space-around; align-items: center;">  <table border="1" style="font-size: 8px; border-collapse: collapse;"> <thead> <tr> <th>CAT. NO.</th> <th>A</th> <th>B</th> <th>C</th> </tr> </thead> <tbody> <tr> <td>4DDA</td> <td>4.00"</td> <td>6.50"</td> <td>6.64"</td> </tr> </tbody> </table> </div>	CAT. NO.	A	B	C	4DDA	4.00"	6.50"	6.64"																				
CAT. NO.	A	B	C																														
4DDA	4.00"	6.50"	6.64"																														
Napoleon Adapter																																	
Black	4" I.D. 6.5" O.D.	4DNAB	Yes	36.67	 <div style="display: flex; justify-content: space-around; align-items: center;">  <table border="1" style="font-size: 8px; border-collapse: collapse;"> <thead> <tr> <th>CAT. NO.</th> <th>A</th> <th>B</th> <th>C</th> </tr> </thead> <tbody> <tr> <td>4DNA</td> <td>4.00"</td> <td>6.50"</td> <td>7.03"</td> </tr> </tbody> </table> </div>	CAT. NO.	A	B	C	4DNA	4.00"	6.50"	7.03"																				
CAT. NO.	A	B	C																														
4DNA	4.00"	6.50"	7.03"																														



Direct Vent Products 4" I.D. - BLACK



		Item #	Stocked	Retail															
90° Swivel Elbow																			
Black	4" I.D. 6.5" O.D.	4D90LB	Yes	82.37	  <table border="1" style="margin-top: 10px; width: 100%; text-align: center;"> <thead> <tr> <th>CAT. NO.</th> <th>A</th> <th>B</th> <th>C</th> <th>D</th> <th>E</th> <th>F</th> </tr> </thead> <tbody> <tr> <td>4D90L</td> <td>4.00"</td> <td>6.50"</td> <td>6.13"</td> <td>7.25"</td> <td>13.38"</td> <td>12.00"</td> </tr> </tbody> </table>	CAT. NO.	A	B	C	D	E	F	4D90L	4.00"	6.50"	6.13"	7.25"	13.38"	12.00"
CAT. NO.	A	B	C	D	E	F													
4D90L	4.00"	6.50"	6.13"	7.25"	13.38"	12.00"													
45° Swivel Elbow																			
Black	4" I.D. 6.5" O.D.	4D45LB	Yes	64.31	  <table border="1" style="margin-top: 10px; width: 100%; text-align: center;"> <thead> <tr> <th>CAT. NO.</th> <th>A</th> <th>B</th> <th>C</th> <th>D</th> <th>E</th> <th>F</th> </tr> </thead> <tbody> <tr> <td>4D45L</td> <td>4.00"</td> <td>6.50"</td> <td>6.12"</td> <td>4.50"</td> <td>17.12"</td> <td>6.50"</td> </tr> </tbody> </table>	CAT. NO.	A	B	C	D	E	F	4D45L	4.00"	6.50"	6.12"	4.50"	17.12"	6.50"
CAT. NO.	A	B	C	D	E	F													
4D45L	4.00"	6.50"	6.12"	4.50"	17.12"	6.50"													



Direct Vent Products 5" I.D. - BLACK









		Item #	Stocked	Retail															
90° Swivel Elbow																			
Black	5" I.D. 8" O.D.	5D90LB	Yes	92.67	  <table border="1" style="margin-top: 10px; width: 100%; text-align: center;"> <thead> <tr> <th>CAT. NO.</th> <th>A</th> <th>B</th> <th>C</th> <th>D</th> <th>E</th> <th>F</th> </tr> </thead> <tbody> <tr> <td>5D90L</td> <td>5.00"</td> <td>8.00"</td> <td>7.75"</td> <td>9.00"</td> <td>16.62"</td> <td>15.25"</td> </tr> </tbody> </table>	CAT. NO.	A	B	C	D	E	F	5D90L	5.00"	8.00"	7.75"	9.00"	16.62"	15.25"
CAT. NO.	A	B	C	D	E	F													
5D90L	5.00"	8.00"	7.75"	9.00"	16.62"	15.25"													
45° Swivel Elbow																			
Black	5" I.D. 8" O.D.	5D45LB	Yes	78.56	  <table border="1" style="margin-top: 10px; width: 100%; text-align: center;"> <thead> <tr> <th>CAT. NO.</th> <th>A</th> <th>B</th> <th>C</th> <th>D</th> <th>E</th> <th>F</th> </tr> </thead> <tbody> <tr> <td>5D45L</td> <td>5.00"</td> <td>8.00"</td> <td>5.25"</td> <td>4.50"</td> <td>15.62"</td> <td>5.93"</td> </tr> </tbody> </table>	CAT. NO.	A	B	C	D	E	F	5D45L	5.00"	8.00"	5.25"	4.50"	15.62"	5.93"
CAT. NO.	A	B	C	D	E	F													
5D45L	5.00"	8.00"	5.25"	4.50"	15.62"	5.93"													

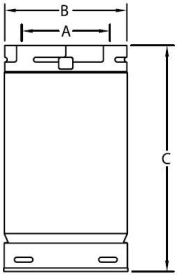

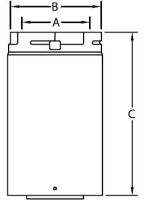
Direct Vent Products 5" I.D. - BLACK

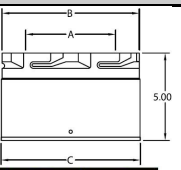

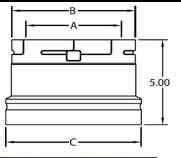
		Item #	Stocked	Retail																													
Straight Length Assembly																																	
Black 5" I.D. 8" O.D.	6"	5D6B	Yes	44.70	 <div style="text-align: right; margin-top: 10px;">  <table border="1" style="margin-top: 10px; font-size: 8px;"> <thead> <tr> <th>CAT. NO.</th> <th>A</th> <th>B</th> <th>C</th> </tr> </thead> <tbody> <tr> <td>5D6</td> <td>5.00"</td> <td>8.00"</td> <td>6.00"</td> </tr> <tr> <td>5D12</td> <td>5.00"</td> <td>8.00"</td> <td>12.00"</td> </tr> <tr> <td>5D18</td> <td>5.00"</td> <td>8.00"</td> <td>18.00"</td> </tr> <tr> <td>5D24</td> <td>5.00"</td> <td>8.00"</td> <td>24.00"</td> </tr> <tr> <td>5D36</td> <td>5.00"</td> <td>8.00"</td> <td>36.00"</td> </tr> <tr> <td>5D48</td> <td>5.00"</td> <td>8.00"</td> <td>48.00"</td> </tr> </tbody> </table> </div>	CAT. NO.	A	B	C	5D6	5.00"	8.00"	6.00"	5D12	5.00"	8.00"	12.00"	5D18	5.00"	8.00"	18.00"	5D24	5.00"	8.00"	24.00"	5D36	5.00"	8.00"	36.00"	5D48	5.00"	8.00"	48.00"
	CAT. NO.	A	B	C																													
	5D6	5.00"	8.00"	6.00"																													
	5D12	5.00"	8.00"	12.00"																													
	5D18	5.00"	8.00"	18.00"																													
	5D24	5.00"	8.00"	24.00"																													
5D36	5.00"	8.00"	36.00"																														
5D48	5.00"	8.00"	48.00"																														
12"	5D12B	Yes	51.59																														
18"	5D18B	Yes	61.07																														
24"	5D24B	Yes	69.90																														
36"	5D36B	Yes	84.62																														
48"	5D48B	Yes	108.77																														
Adjustable Length																																	
Black 3" - 10" Expandable	5" I.D. 8" O.D. Adj Length	5DALB	Yes	52.94	 <div style="text-align: right; margin-top: 10px;">  <table border="1" style="margin-top: 10px; font-size: 8px;"> <thead> <tr> <th>CAT. NO.</th> <th>A</th> <th>B</th> <th>C</th> <th>ADJUSTABLE RANGE</th> </tr> </thead> <tbody> <tr> <td>5DAL</td> <td>5.00"</td> <td>8.00"</td> <td>11.75"</td> <td>3.00" to 10.00"</td> </tr> </tbody> </table> </div>	CAT. NO.	A	B	C	ADJUSTABLE RANGE	5DAL	5.00"	8.00"	11.75"	3.00" to 10.00"																		
CAT. NO.	A	B	C	ADJUSTABLE RANGE																													
5DAL	5.00"	8.00"	11.75"	3.00" to 10.00"																													
DuraVent Adapter																																	
Black	5" I.D. 8" O.D.	5DDAB	Yes	36.75	 <div style="text-align: right; margin-top: 10px;">  <table border="1" style="margin-top: 10px; font-size: 8px;"> <thead> <tr> <th>CAT. NO.</th> <th>A</th> <th>B</th> <th>C</th> </tr> </thead> <tbody> <tr> <td>5DDA</td> <td>5.00"</td> <td>8.00"</td> <td>8.01"</td> </tr> </tbody> </table> </div>	CAT. NO.	A	B	C	5DDA	5.00"	8.00"	8.01"																				
CAT. NO.	A	B	C																														
5DDA	5.00"	8.00"	8.01"																														
Napoleon Adapter																																	
Black	5" I.D. 8" O.D.	5DNAB	Yes	37.71	 <div style="text-align: right; margin-top: 10px;">  <table border="1" style="margin-top: 10px; font-size: 8px;"> <thead> <tr> <th>CAT. NO.</th> <th>A</th> <th>B</th> <th>C</th> </tr> </thead> <tbody> <tr> <td>5DNA</td> <td>5.00"</td> <td>8.00"</td> <td>8.01"</td> </tr> </tbody> </table> </div>	CAT. NO.	A	B	C	5DNA	5.00"	8.00"	8.01"																				
CAT. NO.	A	B	C																														
5DNA	5.00"	8.00"	8.01"																														

In-Stock Items Available within 24 hours or can be picked up from our warehouse!
 Non-Stock items normally available within 7-10 Business Days
 Additional Items Available ~ Check Manufacturer Pricelists



Temp/Guard 2100° 6" Diameter



Description	Item #	Stocked	Retail	
Pipe & Fittings ~ GALVANIZED STEEL				
6" Pipe Length	6TGG6	Yes	68.11	
12" Pipe Length	6TGG12	Yes	98.97	
18" Pipe Length	6TGG18	Yes	125.75	
24" Pipe Length	6TGG24	Yes	158.62	
36" Pipe Length	6TGG36	Yes	209.63	
48" Pipe Length	6TGG48	Yes	259.07	
Insulated Tee w/ Tee Cap	6TGGT	Yes	243.08	
Tee Cap	N/A			
Insulated Tee Cap	6TGITC	Yes	40.02	
15-deg Elbow	6TGGA15	Yes	143.81	
30-deg Elbow	6TGGA30	Yes	188.43	
Pipe & Fittings ~ STAINLESS STEEL				
6" Pipe Length	6TGS6	Yes	76.33	
12" Pipe Length	6TGS12	Yes	110.92	
18" Pipe Length	6TGS18	Yes	140.90	
24" Pipe Length	6TGS24	Yes	177.74	
36" Pipe Length	6TGS36	Yes	234.86	
48" Pipe Length	6TGS48	Yes	288.02	
Insulated Tee w/ Tee Cap	6TGST	Yes	291.02	
Tee Cap	6TGTC	Yes	19.20	
Insulated Tee Cap	N/A			
15-deg Elbow	6TGSA15	Yes	161.16	
30-deg Elbow	6TGSA30	Yes	211.17	

Note: Twist Lock Pipe overlaps 1-1/2" when joined together.
Therefore, assembled length is 1-1/2" less than listed length



Temp/Guard 2100° 6" Diameter

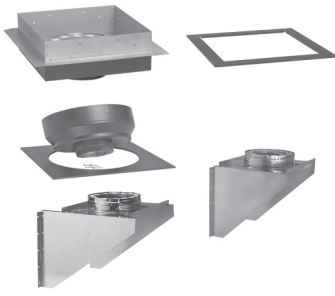
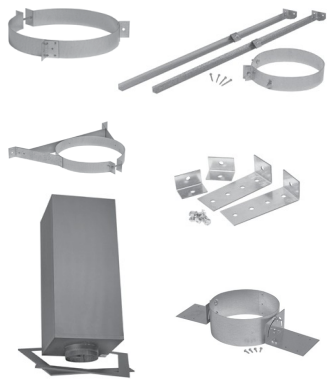
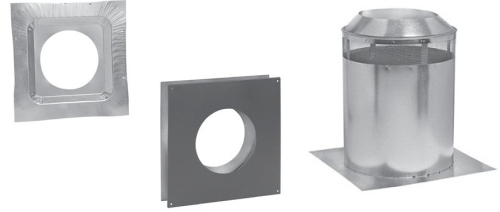

Description	Item #	Stocked	Retail	
Supports				
Aluminum				
Anchor Plate	6TGAP	Yes	91.23	
Galvanized				
Painted Ceiling Support	6TGCSP	Yes	139.79	
Painted Ceiling Support Trim	6TGCST	Yes	46.69	
Deluxe Support	6TGDLS	Yes	194.30	
Wall Support/ Adapter	6TGWS	Yes	136.03	
Wall Support, Adjustable	6TGAWS	Yes	157.60	
Support Band	6TGSB	Yes	23.87	
Roof Brace Kit	6TGRB	Yes	121.52	
Wall Band	6TGWB	Yes	45.92	
Wall Band Adjustment Kit	TGWBA	Yes	40.08	
Roof Support w/Trim	6TGRS	Yes	180.28	
Adjustable Roof Support	6TGAS	Yes	58.46	
Firestops ~ Galvanized Available Only				
Firestop Assembly	6TGFA	Yes	21.51	
Attic Insulation Shield	6TGIS	Yes	136.17	
Wall Firestop	6TGWFS	Yes	87.46	

Note: Insulation shield must be used anytime the chimney system passes through an attic. TGIS is used to prevent the insulation from coming in contact with the pipe. This part is required on **any** attic pass-through situation, regardless if insulation is present or not.

Application Reminder: For oil or coal burning appliances, use only pipe with S.S. casing and S.S. or aluminum accessory components outside the envelope of the building.

Appliance Caution: Temp/Guard is intended for use in residential and building appliances that operate at **continuous** temperatures below 1000°.



Temp/Guard 2100° 6" Diameter



Description	Item #	Stocked	Retail	
Pitched Ceiling Plates & Accessories ~ Galvanized Available Only				
PCP 0/12 - 2/12 Pitch	6TGPCP2	Yes	44.85	
PCP 4/12 Pitch	6TGPCP4	Yes	44.85	
PCP 6/12 Pitch	6TGPCP6	Yes	44.85	
PCP 8/12 Pitch	6TGPCP8	Yes	44.85	
PCP 10/12 Pitch	6TGPCP10	Yes	44.85	
Painted Trim Sleeve	6TGTS	Yes	32.96	
Painted Single Wall Adapter	6TGPSWA	Yes	74.01	
Flashing				
Aluminum				
Flat Tall Cone 0/12 - 2/12	6TGAFT	Yes	99.33	
Flashing 2/12 - 5/12	6TGAF	Yes	75.15	
Flashing 6/12 - 10/12	6TGAF10	Yes	112.06	
Flashing 11/12 - 15/12	6TGAF15	Yes	161.41	
Flashing 16/12 - 24/12	6TGAF24	Yes	261.66	
Galvanized				
Flat Tall Cone 0/12 - 2/12	6TGFT	Yes	88.58	
Flashing 2/12 - 5/12	6TGF	Yes	67.01	
Flashing 6/12 - 10/12	6TGF10	Yes	100.06	
Flashing 11/12 - 15/12	6TGF15	Yes	143.79	
Flashing 16/12 - 24/12	6TGF24	Yes	233.52	
Dead Soft AL Flashing	6TGDSF	Yes	114.52	

Note: Dead soft flashing for use with metal, corrugated and tile applications



Temp/Guard 2100° 6" Diameter



Description	Item #	Stocked	Retail	
Termination Components				
Stainless Steel				
Cap/Spark Arrester	6TGC	Yes	126.50	
Cap (Detachable)**	6TGDC	Yes	127.18	
Cap (Rain Cap)	6TGRC	Yes	81.20	
Storm Collar* *Aluminum	6TGASC	Yes	22.42	
Galvanized				
Storm Collar	6TGSC	Yes	19.47	

TEMP/GUARD INTERIOR - NO OFFSET

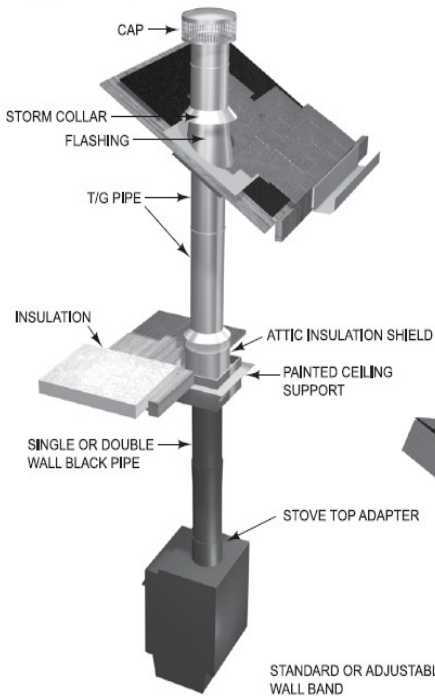

TEMP/GUARD PITCHED CEILING



TEMP/GUARD HIGH-PITCHED CATHEDRAL CEILING

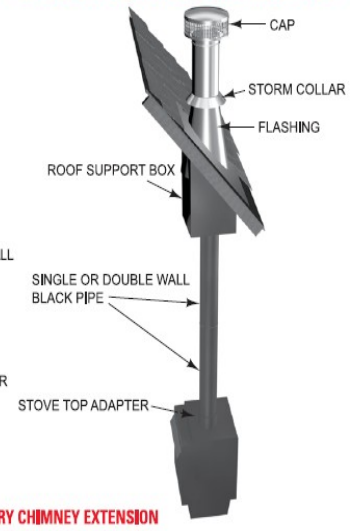

TEMP/GUARD EXTERIOR

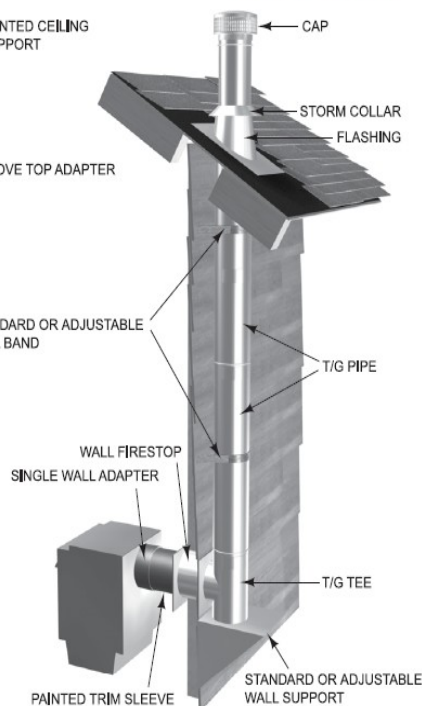

TEMP/GUARD MASONRY CHIMNEY EXTENSION

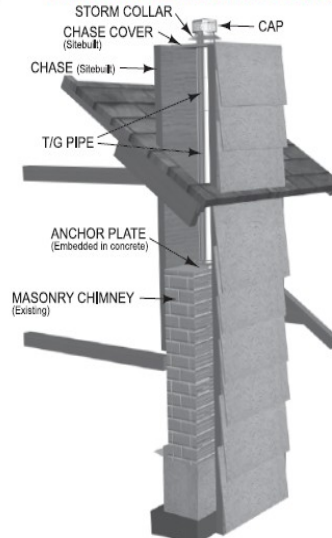





Typical Installation Drawings



Black Stove Pipe 6" Diameter



Description	Item #	Stocked	Retail	
Single Wall				
12" Pipe Length	6SW12	Yes	24.32	
24" Pipe Length	6SW24	Yes	37.49	
48" Pipe Length	6SW48	Yes	63.98	
14" Slip Connector	6SW14S	Yes	28.88	
48" Telescoping 26"-48"	6SWTL48	Yes	97.43	
66" Telescoping 36"-66"	6SWTL66	Yes	111.64	
45° Elbow	6SW45	Yes	32.60	
90° Elbow	6SW90	Yes	36.07	
Tee / Tee Cap	6SWT	Yes	93.11	
Stove Top Adapter	6SWA1	Yes	20.54	
Trim Collar	6SWTC	Yes	14.84	
6" to 8" Increaser	6SWI-8	Yes	44.97	
Double Wall				
12" Pipe Length	6DWB12	Yes	93.62	
24" Pipe Length	6DWB24	Yes	145.31	
48" Pipe Length	6DWB48	Yes	191.39	
8" Adjustable 3"-6"	6DWB8A	Yes	85.50	
18" Adjustable 6"-16"	6DWB18A	Yes	118.18	
48" Telescoping 26"-48"	6DWBTL48	Yes	210.65	
66" Telescoping 36"-66"	6DWBTL66	Yes	251.59	
45° Elbow	6DWB45	Yes	100.32	
90° Elbow	6DWB90	Yes	163.42	
Tee / Tee Cap	6DWBT	Yes	157.32	
Stove Top Adapter	6DWBA	Yes	46.16	
6" to 8" Increaser	6DWBI-8	Yes	55.70	

Note: Single Wall Pipe overlaps 1" when joined together. Therefore, assembled length is 1" less than listed length.
Double Wall Pipe overlaps 1-1/2" when joined together. Therefore, assembled length is 1-1/2" less than listed length.



BestFlex Crossover Series

Stainless Steel Smooth Wall Liner for Wood Applications



Item #	Style	Length	Diameter	Price Per Foot
CO8-B	304 Stainless Steel	Custom	8-in	91.00
CO9-B	304 Stainless Steel	Custom	9-in	115.00
CO10-B	304 Stainless Steel	Custom	10-in	122.00
CO11-B	304 Stainless Steel	Custom	11-in	140.00
CO12-B	304 Stainless Steel	Custom	12-in	158.00
CO711REC-B	304 Stainless Steel	Custom	7-in x 11-in	120.00

Exhausto Fans

(Does not include electrical work)

Item #	Amps	RPM	CFM	MSRP	
RS 009	.5	1600	450	1900.00	
RS 012	1.2	1600	950	2242.00	
RS 014	1.4	1600	1400	2416.00	
RS 016	3.9	1600	1950	3267.00	



BestFlex Elite Series Stainless Steel Liner





Item #	Style	Length	Diameter	Thickness	Price Per Foot
E9-R6	316 Titanium Stainless Steel	Custom	9-in	.006	75.00
E10-R6	316 Titanium Stainless Steel	Custom	10-in	.006	80.00
17011 while supplies last	316 Ti-Alloy Stainless	Copperfield Custom	11-in	.006	85.00
E12-R6	316 Titanium Stainless Steel	Custom	12-in	.006	90.00



BestFlex Elite Series 316



BestFlex Elite Series 316



Item #	Style	Use	Diameter	Retail Price	
CE9-R	Slip Connector	Male-end down joints	9-in	84.00	 
CE10-R	Slip Connector	Male-end down joints	10-in	96.00	
21119 Copperfield while supplies last	2 Band Connector	Male-end down joints	11-in	116.00	
CE12-R	Slip Connector	Male-end down joints	12-in	109.00	
TPCE9-1818-B18	Top Plate	18-in x 18-in	9-in	147.00	
TPCE10-1818-B18	Top Plate	18-in x 18-in	10-in		
TPCE11-1818-B18	Top Plate	18-in x 18-in	11-in		
TPCE12-1818-B18	Top Plate	18-in x 18-in	12-in		

In-Stock Items Available within 24 hours or can be picked up from our warehouse!
 Non-Stock items normally available within 7-10 Business Days
 Additional Items Available ~ Check Manufacturer Pricelists

HYC HY-C Single-Flue Stainless Steel Caps **HYC**

Size	Item #	Stocked	Fits	Installed Cost	
9" x 9"	SS99U	Yes	7½" x 7½" to 9½" x 9½"	219.99	 <ul style="list-style-type: none"> • 100% Stainless Steel • 24-Gauge Lid • 18-Gauge Mesh • 16-Gauge Base • Heavier and stronger than many competitive brands
9" x 13"	SS913U	Yes	7½" x 11½" to 9½" x 13½"	239.99	
9" x 18"	SS918U	Yes	7½" x 16½" to 9½" x 18½"	259.99	
11" x 11"	SS1111U	Yes	9¾" x 9¾" to 12" x 12"	249.99	
13" x 13"	SS1313U	Yes	11½" x 11½" to 13½" x 13½"	229.99	
13" x 18"	SS1318U	Yes	11½" x 16½" to 13½" x 18½"	259.99	
18" x 18"	SS1818U	Yes	16½" x 16½" to 18" x 18"	289.99	

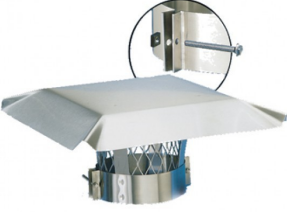
HYC HY-C Stainless Steel Caps **HYC**

Size	Item #	Stocked	Fits	Installed Cost	
5" Liner Cap	LC5	Yes	Fits O.D Liner 3½"-4½"	209.99	 <ul style="list-style-type: none"> • 304 Stainless Steel • 24-Gauge Lid and Base • 18-Gauge Mesh and Braces
6" Liner Cap	LC6	Yes	Fits O.D Liner 5½"-6½"	219.99	
7" Liner Cap	LC7	Yes	Fits O.D Liner 6½"-7½"	224.99	
8" Liner Cap	LC8	Yes	Fits O.D Liner 7½"-8½"	229.99	
10" Round Cap	SS10U	Yes	Fits O.D Liner 9½"-10½"	279.99	 <ul style="list-style-type: none"> • 304 Stainless Steel • 24-Gauge Lid and Base • 18-Gauge Mesh and Braces
12" Round Cap	SS12U	Yes	Fits O.D Liner 11½"-12½"	289.99	
14" Round Cap	SS14U	Yes	Fits O.D Liner 13½"-14½"	299.99	

HYC HY-C Single-Flue Stainless Steel Caps Slip-in **HYC**

Size	Item #	Stocked	Fits	Installed Cost	
10"	SS811U	Yes	O.D Dia. 9½" to 10½"	279.99	
12"	SS813U	Yes	O.D Dia. 11½" to 12½"	289.99	
14"	SS815U	Yes	O.D Dia. 13½" to 14½"	299.99	

HY-C Single-Flue Galvanized Caps

9" x 9"	CB099	Yes	7½" x 7½" to 9½" x 9½"	159.99	
9" x 13"	CB0913	Yes	7½" x 11½" to 9½" x 13½"	169.99	
13" x 13"	CB01313	Yes	11½" x 11½" to 13½" x 13½"	172.99	

The Energy Top Damper

Size	Item #	Stocked	Fits	Installed Cost
8"x 8"	ET88	Yes	6"x 6" to 9" x 9"	460.99
9"x 13"	ET913	Yes	6"x 9" to 9½" x 12½"	479.99
8"x 17"	ET817	Yes	6"x 14" to 9" x 17½"	591.99
13"x 13"	ET1313	Yes	9"x 9" to 12½" x 12½"	499.99
13"x 18"	ET1318	Yes	9"x 14" to 12½" x 17½"	599.99
18"x 18"	ET1818	Yes	14"x 14" to 17½" x 17½"	699.99



The Energy Plus Top Damper

Size	Item #	Stocked	Fits	Installed Cost
8"x 8"	ETP88	Yes	6"x 6" to 9" x 9"	699.99
9"x 13"	ETP913	Yes	6"x 9" to 9½" x 12½"	739.99
8"x 17"	ETP817	Yes	6"x 14" to 9" x 17½"	939.99
13"x 13"	ETP1313	Yes	9"x 9" to 12½" x 12½"	807.99
13"x 18"	ETP1318	Yes	9"x 14" to 12½" x 17½"	879.99
18"x 18"	ETP1818	Yes	14"x 14" to 17½" x 17½"	899.99



RS Adapters for above Dampers

Lindemann

8"x8" - 6"	120306	No	8"x8" to 6" Round	157.47
8"x8" - 7"	120307	No	8"x8" to 7" Round	166.92
8"x8" - 8"	120308	No	8"x8" to 8" Round	161.97
13"x13" - 9"	120309	No	13"x13" to 9" Round	170.07
13"x13" - 10"	120310	No	13"x13" to 10" Round	192.12
13"x13" - 11"	120311	No	13"x13" to 11" Round	195.27
13"x13" - 12"	120312	No	13"x13" to 12" Round	198.42



In-Stock Items Available within 24 hours or can be picked up from our warehouse!

Non-Stock items normally available within 7-10 Business Days

Additional Items Available ~ Check Manufacturer Pricelists

Round Pot Toppers with Cone Lid ~ Stainless Steel

Size	Item #	Stocked	Fits	Installed Cost
<8"	PTSSCONE<8	No	Under 8" Round	499.00
8" to 9-1/2"	PTSSCONE810	No	8" to 9-1/2"	599.00
10" to 11-1/2"	PTSSCONE1012	No	10" to 11-1/2"	699.00
12" to 13-1/2"	PTSSCONE1214	No	12" to 13-1/2"	799.00
14" to 15-1/2"	PTSSCONE1416	No	14" to 15-1/2"	899.00



Round Pot Toppers with Cone Lid ~ Copper

Size	Item #	Stocked	Fits	Installed Cost
<8"	PTCPCONE<8	No	Under 8" Round	599.00
8" to 9-1/2"	PTCPCONE810	No	8" to 9-1/2"	699.00
10" to 11-1/2"	PTCPCONE1012	No	10" to 11-1/2"	799.00
12" to 13-1/2"	PTCPCONE1214	No	12" to 13-1/2"	899.00
14" to 15-1/2"	PTCPCONE1416	No	14" to 15-1/2"	999.00



Round Pot Toppers with Octagon Lid ~ Stainless Steel

Size	Item #	Stocked	Fits	Installed Cost
<8"	PTSSOCT<8	No	Under 8" Round	549.00
8" to 9-1/2"	PTSSOCT810	No	8" to 9-1/2"	649.00
10" to 11-1/2"	PTSSOCT1012	No	10" to 11-1/2"	749.00
12" to 13-1/2"	PTSSOCT1214	No	12" to 13-1/2"	849.00
14" to 15-1/2"	PTSSOCT1416	No	14" to 15-1/2"	949.00



Round Pot Toppers with Octagon Lid ~ Copper

Size	Item #	Stocked	Fits	Installed Cost
<8"	PTCPOCT<8	No	Under 8" Round	649.00
8" to 9-1/2"	PTCPOCT810	No	8" to 9-1/2"	749.00
10" to 11-1/2"	PTCPOCT1012	No	10" to 11-1/2"	849.00
12" to 13-1/2"	PTCPOCT1214	No	12" to 13-1/2"	949.00
14" to 15-1/2"	PTCPOCT1416	No	14" to 15-1/2"	1049.00



In-Stock Items Available within 24 hours or can be picked up from our warehouse!
 Non-Stock items normally available within 7-10 Business Days
 Additional Items Available ~ Check Manufacturer Pricelists

Custom Chase Top ~ Stainless Steel

Add width + length + (4x skirt height)

(If chase top is 30"x30" with a 3" skirt, the equation is: 30+30+(4x3) resulting in a 72" measurement)

Size	Stocked	Installed Cost
65"-75"	No	687.50
76"-85"	No	750.00
86"-95"	No	820.00
96"-105"	No	890.00
106"-115"	No	960.00
116"-125"	No	1030.00
126"-135"	No	1100.00



Custom Chase Top ~ Galvanized Steel

Add width + length + (4x skirt height)

(If chase top is 30"x30" with a 3" skirt, the equation is: 30+30+(4x3) resulting in a 72" measurement)

Size	Stocked	Installed Cost
65"-75"	No	620.00
76"-85"	No	675.00
86"-95"	No	740.00
96"-105"	No	800.00
106"-115"	No	860.00
116"-125"	No	925.00
126"-135"	No	990.00



Adjustable Storm Collars - Aluminum

Size	Item #	Stocked	Fits	Installed Cost
5"-8"	SC58	No	5" - 8"	25.00
9"-12"	SC912	No	9"-12"	25.00
13"-16"	SC1316	No	13"-16"	25.00

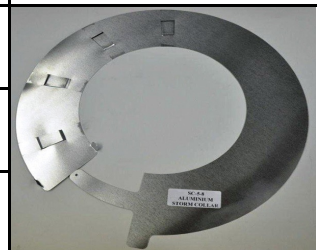

In-Stock Items Available within 24 hours or can be picked up from our warehouse!

Non-Stock items normally available within 7-10 Business Days

Additional Items Available ~ Check Manufacturer Pricelists

The Seal Tight Damper

Size	Item #	Stocked	Fits	Installed Cost
8" x 8"	ST88	No	6" x 6" to 9" x 9"	363.99
9" x 13"	ST913	No	6" x 9" to 9½" x 12½"	369.99
8" x 17"	ST817	No	6" x 14" to 9" x 17½"	408.99
12" x 16"	ST1216	No	9" x 13" to 11½" x 16½"	453.99
13" x 13"	ST1313	Yes	9" x 9" to 12½" x 12½"	389.99
13" x 18"	ST1318	No	9" x 14" to 12½" x 17½"	450.99
18" x 18"	ST1818	No	14" x 14" to 17½" x 17½"	567.99



Drop-In Dampers/Spider Dampers -Lindemann

6" Dia	PDD6	No	6" Diameter	351.97
7" Dia	PDD7	No	7" Diameter	361.42
8" Dia	PDD8	No	8" Diameter	386.62
8" x 13"	PDD813	No	8" x 13"	339.37
9" Dia	PDD9	No	9" Diameter	396.07
10" Dia	PDD10	No	10" Diameter	405.52
11" Dia	PDD11	No	11" Diameter	449.62
12" Dia	PDD12	No	12" Diameter	459.07
12" x 12"	PDD1212	No	12" x 12"	355.12
13" x 13"	PDD1313	No	13" x 13"	374.62
14" Dia	PDD14	No	14" Diameter	528.37
16" Dia	PDD16	No	16" Diameter	563.02



HY-C Stainless Steel Leg Kit

Size	Item #	Stocked	Fits	Retail Price
	SSLK	Yes	Fits Hy-C Caps	29.99



Fireplace SmokeGuard ~ Fits 28.5" to 48" wide

28.5 x 2 x 4	FSG-BLK-4	Yes	Heat resistant adhesive caulk included	129.99
28.5 x 2 x 6	FSG-BLK-6	Yes	Heat resistant adhesive caulk included	139.99
28.5 x 2 x 8	FSG-BLK-8	Yes	Heat resistant adhesive caulk included	149.99



Accessories for The Top Damper and Top Damper Plus

50' Cable	ETTD-50	Yes	All Sizes	59.99
Hardware Kit	ETHK-50	Yes		59.99



Super Wool + Insulation Blanket

3-mil Aluminum Facing, All Rolls are 25' Long ~ Used as an insulator for stainless steel liners in masonry chimneys and wood burning applications; For wood burning applications, usually two wraps of 1/4" or one wrap of 1/2" insulation is required

Thickness	Width	Stocked	Item #	Installed Cost	
1/4"	24"	Yes	SW424	197.99	
1/4"	48"	Yes	SW448	392.99	
1/2"	24"	Yes	SW224	299.99	
1/2"	48"	Yes	SW248	589.99	

Flexi-Sleeve

Flexi-Sleeve	Length	Stocked	Item #	Installed Cost	
3" / 4" Flexi-Sleeve	10' Length	Yes	77100	100.99	
5" Flexi-Sleeve	10' Length	Yes	77101	113.99	
5.5" / 6" Flexi-Sleeve	10' Length	Yes	77102	129.99	

Stainless Steel Mesh

Fit	Length	Stocked	Item #	Installed Cost	
Small fits 3"-6" dia	25' Length	Yes	391101	81.99	
MED fits 7"-9" dia	25' Length	Yes	391102	108.99	
LG fits 10"-12" dia	25' Length	Yes	391103	147.99	

TherMix Insulation 40 lb. Bag, 3.25 cu.ft. per bag

Size	40 lb. Bag
Stocked	Yes
Item #	TM40325
Installed Cost	89.99



Flue Opening	Diameter of Liner					
	5"	6"	7"	8"	10"	12"
7.5" x 7.5"	0.08	0.06	—	—	—	—
7.5" x 11.5"	0.14	0.12	0.12	0.10	—	—
8.5" x 8.5"	0.11	0.09	0.07	—	—	—
8.5" x 11.5"	0.17	0.15	0.13	0.11	0.10	—
9.5" x 9.5"	0.15	0.13	0.11	0.08	—	—
11.5" x 11.5"	0.24	0.22	0.20	0.18	0.11	—
11.5" x 16.5"	0.36	0.34	0.32	0.30	0.24	—
12.5" x 12.5"	0.29	0.27	0.25	0.22	0.16	—
14.5" x 14.5"	0.40	0.39	0.37	0.34	0.28	0.20
14.5" x 18.5"	0.52	0.51	0.49	0.46	0.40	0.32

To determine the number of bags needed for your application, find the flue opening and the diameter of the liner in the chart to the right. Multiply the number where the two intersect by the height in feet of the chimney to give an estimate of the number of bags needed. Remember to have extra on hand "just in case".



Drescher Combustion Air Vent



	Item #	Stocked	Retail Price	
Drescher Air Vent	DCAV	Yes	159.99*	Air Vent Kits include one grille to complete installation. Additional grilles can be ordered for stock or replacement.
Drescher Air Vent Grille	DCAV-Grille 4" Grille	Yes	26.99	

**Labor to install Drescher Air Vent: \$350.00*

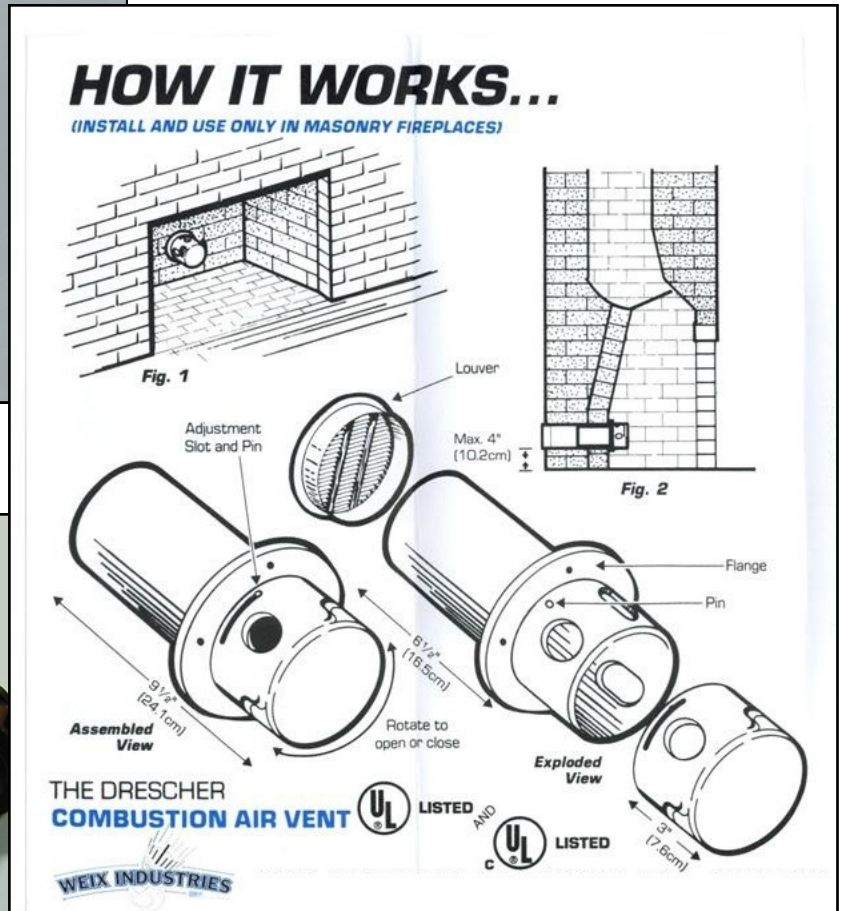

In-Stock Items Available within 24 hours or can be picked up from our warehouse!
Non-Stock items normally available within 7-10 Business Days
Additional Items Available ~ Check Manufacturer Pricelists

AIRJET Continental Chimney Housing **AIRJET**

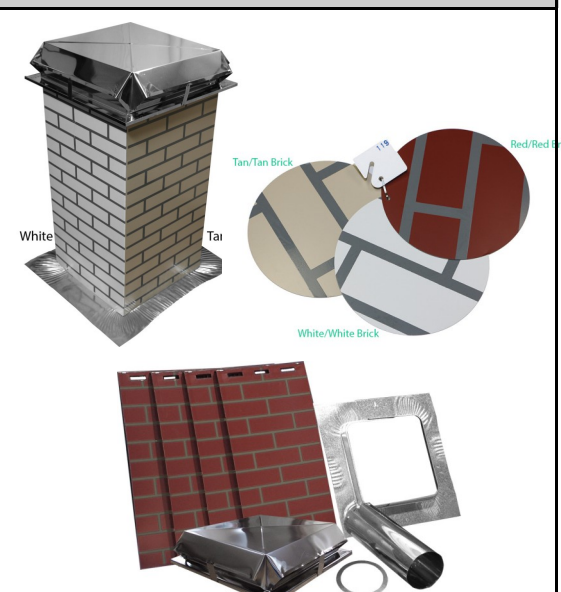
Description	Item #	Stocked	Installed Price	
Simulated Brick Side Panels Includes Panels (4), SS Cap, Flashing (2) and 18" Connector and 7" into 5" reducer				
17x17x36 Red Brick	GHL36R	Yes	699.99	
17x17x36 Tan Brick	GHL36T	Yes	699.99	
17x17x36 White Brick	GHL36W	Yes	699.99	
17x17x48 Red Brick	GHL48R	Yes	868.99	
17x17x48 Tan Brick	GHL48T	Yes	868.99	
17x17x48 White Brick	GHL48W	Yes	868.99	
17x17x60 Red Brick	GHL60R	Yes	1199.99	
17x17x60 Tan Brick	GHL60T	Yes	1199.99	
17x17x60 White Brick	GHL60W	Yes	1199.99	

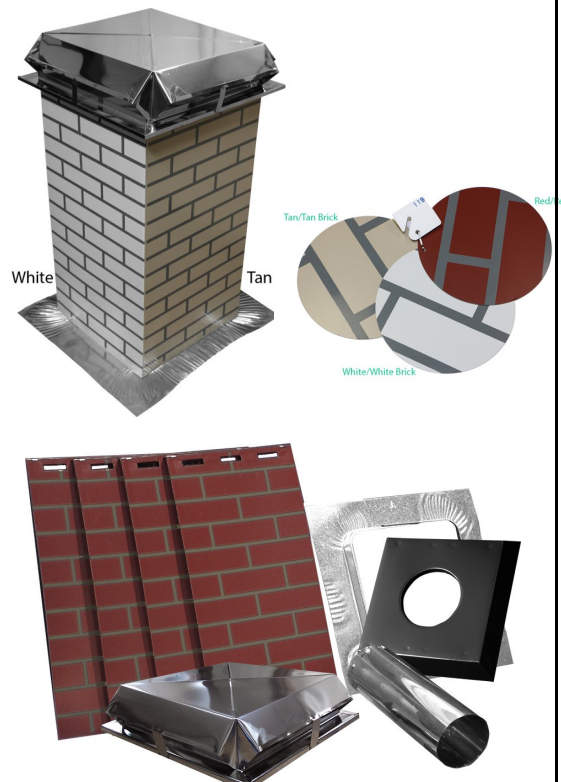
Simulated Brick Side Panels Includes Panels (4), SS Cap, Flashing (2) and 18" Connector (8" dia.) and Ceiling Cover/Base Support				
17x17x36 Red Brick	8HL36R	Yes	999.99	
17x17x36 Tan Brick	8HL36T	Yes	999.99	
17x17x36 White Brick	8HL36W	Yes	999.99	
17x17x48 Red Brick	8HL48R	Yes	1099.99	
17x17x48 Tan Brick	8HL48T	Yes	1099.99	
17x17x48 White Brick	8HL48W	Yes	1099.99	
17x17x60 Red Brick	8HL60R	Yes	1399.99	
17x17x60 Tan Brick	8HL60T	Yes	1399.99	
17x17x60 White Brick	8HL60W	Yes	1399.99	



Cements, Mortars & Sealants



	Item #	Stocked	Retail	
Fireplace Mortar 10.3 fl oz	63 Black	Yes	9.99	
	63B Buff	Yes	9.99	
	63G Gray	Yes	9.99	
Castable Refractory Cement 25 lbs	601	Yes	74.99	
High Heat Silicone Sealant	76C 10.3 oz Clear	Yes	19.99	
	76A 2.3 oz Black	Yes	12.99	
	76CT 2.3 oz Clear	Yes	12.99	



Fire Starters & Crystals





Safe Lite® Fire Starters	50B 144 Squares	Yes	25.99	
	50C 24 Squares	Yes	7.99	
One Match® Gelled Fire Starters	49 16 fl oz	Yes	10.99	
Rainbow Flame	715 15 oz crystals	Yes	9.99	
	715S Stick	Yes	3.39	

In-Stock Items Available within 24 hours or can be picked up from our warehouse!
 Non-Stock items normally available within 7-10 Business Days
 Additional Items Available ~ Check Manufacturer Pricelists

RUTLAND Polishes, Paints & Cleaners **RUTLAND**





	Item #	Stocked	Retail	
1200° Hi-Temp Paint Flat Black	80 Spray-on 12 fl oz	Yes	19.99	 
	81 Brush-on 16 fl oz	Yes	29.99	
Fireplace Glass Cleaner	82 32 fl oz	Yes	14.99	
Brick & Stone Cleaner	83-6 16 fl oz	Yes	10.99	
Magic Wooly Bully	88 2 per bag	Yes	29.99	 
William's® Stove Polish Black	WI-00710 2.3 fl oz	Yes	9.99	
Damp Gone Moisture Absorber Reusable	620	Yes	9.99	

RUTLAND Log Maintenance **RUTLAND**

White Off® Glass-Ceramic Cleaning Cream	565 8 fl oz	Yes	9.99	
Log Brite Gas Log Soot Remover	570-6 16 fl oz	Yes	15.99	

In-Stock Items Available within 24 hours or can be picked up from our warehouse!
Non-Stock items normally available within 7-10 Business Days
Additional Items Available ~ Check Manufacturer Pricelists

RUTLAND Chimney Care **RUTLAND**

	Item #	Stocked	Retail	
Chimney Shield Water Repellant	25CS 2.5 Gallon	Yes	129.99	
Wet or Dry Roof Patch	510 10.3 oz cartridge	Yes	7.99	
Clean the Air Pump Spray	86 8 fl oz	Yes	12.99	
Chimney Masonry Patch-Exterior	89 10.3 oz cartridge	Yes	10.99	
Stove and Gasket Cement	77	Yes	9.99	

RUTLAND Accessories **RUTLAND**





Stack and Store Brackets	30360R set of 4	Yes	29.99	
Stove Thermometer Burn Indicator	701	Yes	28.99	
Leather Fireplace Gloves	702	Yes	29.99	
Fire Bricks	604 box of 6	Yes	39.99	

www.FireplaceandChimneyAuthority.com

Fire Grates







VESTAL

VESTAL

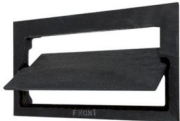
	Item #	Stocked	Retail Price	
Heavy Duty Cast Iron Front x Back x Depth Leg Height 3 ⁵ / ₈ "	321-ML 21" x 17 ³ / ₄ " x 14 ³ / ₄ "	Yes	64.99	
	324-ML 24" x 20 ³ / ₄ " x 14 ³ / ₄ "	Yes	69.99	
	327-ML 27" x 23 ³ / ₄ " x 14 ³ / ₄ "	Yes	79.99	
	330-ML 30" x 26 ³ / ₄ " x 14 ³ / ₄ "	Yes	84.99	
Self-Feeding Cast Iron Grate Front x Back x Depth Leg Height 2 ¹ / ₄ "	SF-22 23 ³ / ₄ " x 18" x 15"	Yes	109.99	
	SF-26 26 ¹ / ₂ " x 22" x 15"	Yes	126.99	
5/8" Square Steel Bar Grate Front x Back x Depth Leg Height 3 ¹ / ₂ "	SD-18 18" x 16" x 12"	Yes	49.99	
	SD-24 24" x 20" x 12"	Yes	59.99	
	SD-27 27" x 24" x 12"	Yes	69.99	
3/4" Square Steel Bar Grate Front x Back x Depth Leg Height 3 ¹ / ₂ "	XB-24 24" x 20" x 15"	Yes	69.99	
	XB-27 27" x 23" x 15"	Yes	79.99	
	XB-30 30" x 26" x 15"	Yes	89.99	
	XB-36 36" x 32" x 15"	Yes	119.99	

www.FireplaceandChimneyAuthority.com

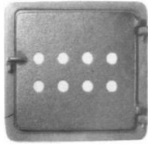
In-Stock Items Available within 24 hours or can be picked up from our warehouse!
 Non-Stock items normally available within 7-10 Business Days
 Additional Items Available ~ Check Manufacturer Pricelists

VESTAL		Ash Dumps and Cleanouts			VESTAL	
	Item #	Stocked	Retail Price			
Ash Dump Cast Iron	49 4½" x 9"	Yes	24.99			
Vented Ash Dump Cast Iron	94CI0A 4½" x 9"	Yes	42.99			
Ash Caddy Cast Iron Grille Galvanized Pail	AC 9½" x 9½"	Yes	95.99			
Cast Iron Cleanout Doors	H-88 8" x 8"	Yes	59.99			
	108 10" x 8"	Yes	69.99			
	128 12" x 8"	Yes	79.99			
	1212 12" x 12"	Yes	109.99			
Steel Cleanout Doors	ST-88 8" x 8"	Yes	39.99			
	ST-108 10" x 8"	Yes	69.99			
Vented Cast Iron Cleanout Doors	88CI0A 8" x 8"	Yes	69.99			
VESTAL		Damper Controls			VESTAL	
Rotary Control For sizes 24" thru 48"	15-001	Yes	69.99			
Damper Control For sizes 24" thru 48"	15-003	Yes	29.99			

In-Stock Items Available within 24 hours or can be picked up from our warehouse
 Non-Stock items normally available within 7-10 Business Days
 Additional Items Available ~ Check Manufacturer Pricelists

Firepits

	Item #	Stocked	Retail Price	
Round Firepit with flip grill	28-006 32" I.D.	Yes	309.99	
Round Firepit	28-007 32" I.D.	Yes	249.99	
Round Log Grate 6" High	28-008 32" O.D.	Yes	89.99	
Square Firepit with flip grill	28-009 28" x 28"	Yes	359.99	
Square Firepit	28-010 28" x 28"	Yes	279.99	
Square Log Grate 6" High	28-011 28" x 28"	Yes	94.99	

Firepits



	Item #	Stocked	Retail Price	
Round Fire Pit Grate 5/8" Carbon Steel Barstock 4" Legs	24FPGRATE	Yes	154.00	 
	27FPGRATE	Yes	170.00	
	30FPGRATE	Yes	190.00	
	33FPGRATE	Yes	220.00	
	36FPGRATE	Yes	275.00	
	38FPGRATE	Non-Stock	330.00	
	Round Snuffer Lid 18 Gauge Galvanized Metal Plated Finish Welded Handle	30RFPC	Yes	
36RFPC		Yes	181.00	
42RFPC		Non-Stock	192.00	
48RFPC		Non-Stock	214.00	

In-Stock Items Available within 24 hours or can be picked up from our warehouse!
Non-Stock items normally available within 7-10 Business Days
Additional Items Available ~ Check Manufacturer Pricelists

Abbeville **Fireplace Ember Grates** **Abbeville**

	Item #	Stocked	Size	Retail	
Ember Grates Includes screen/grid underneath bars to keep hot coals up where they can keep a hotter fire burning	SAW-GEMHD2217	Yes	3/4" Square Bar ~ 6 Bar 6" Clearance Depth: 17" Width: 22"	128.00	
	SAW-GEMHD2517	Yes	3/4" Square Bar ~ 7 Bar 6" Clearance Depth: 17" Width: 25"	143.00	
	SAW-GEMHD2817	Yes	3/4" Square Bar ~ 8 Bar 6" Clearance Depth: 17" Width: 28"	162.00	
	SAW-GEMHD3217	Yes	3/4" Square Bar ~ 9 Bar 6" Clearance Depth: 17" Width: 32"	187.00	

Abbeville **Fireplace Tool Sets** **Abbeville**

Simple 5-Piece Iron Tool Set Stand, Shovel, Broom, Poker and Grapple	SATCHPBZ	Yes	27" High Bronzed Iron	204.00	
	SATCHPSP	Yes	27" High Charcoal	204.00	
	SATOBPSP	Yes	27" High Oil Rubbed Bronze	204.00	
	SATTBPSP	Yes	27" High Textured Black	204.00	
Shepard's Hook Poker	SATOFK36	Yes	36" High Textured Black	85.00	
Shepard's Hook Tong	SATOTG36	Yes	36" High Textured Black	106.00	

In-Stock Items Available within 24 hours or can be picked up from our warehouse!
 Non-Stock items normally available within 7-10 Business Days
 Additional Items Available ~ Check Manufacturer Pricelists

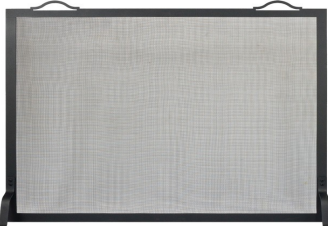
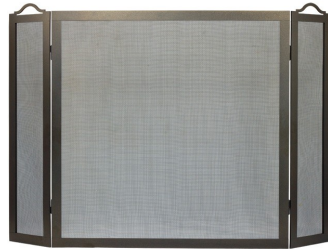
<i>Abbeville</i>	Fireplace Screens			<i>Abbeville</i>
	Item #	Stocked	Retail	
Rectangular Screen 39" x 31"	SAFSESRE3931BZ Bronzed Iron	Yes	214.00	
	SAFSESRE3931CH Charcoal	Yes	214.00	
	SAFSESRE3931OB Oil Rubbed Bronze	Yes	214.00	
	SAFSESRE3931TB Textured Black	Yes	214.00	
Rectangular Screen 44" x 34"	SAFSESRE4434BZ Bronzed Iron	Yes	236.00	
	SAFSESRE4434CH Charcoal	Yes	236.00	
	SAFSESRE4434OB Oil Rubbed Bronze	Yes	236.00	
	SAFSESRE4434TB Textured Black	Yes	236.00	
3-Panel Screen 30" x 30" with 8" wings	SAFSESTP83030BZ Bronzed Iron	Yes	290.00	
	SAFSESTP83030CH Charcoal	Yes	290.00	
	SAFSESTP83030OB Oil Rubbed Bronze	Yes	290.00	
	SAFSESTP83030TB Textured Black	Yes	290.00	

In-Stock Items Available within 24 hours or can be picked up from our warehouse!
Non-Stock items normally available within 7-10 Business Days
Additional Items Available ~ Check Manufacturer Pricelists



Realfyre™ Gas Logs



Vented



Stocked items listed, additional items available. Please call with questions.

Style	Item #	Length	Compatible Burners	MSRP	
Charred American Oak Best Seller	CHAO-18	18"	G4, G31, G45, G46	423.50	
Charred American Oak Best Seller	CHAO-24	24"	G4, G31, G45, G46	478.50	
Charred American Oak Best Seller	CHAO-30	30"	G4, G31, G45, G46	605.50	
American Oak	AO-18	18"	G4, G45, G46	379.50	
American Oak	AO-24	24"	G4, G45, G46	433.50	
American Oak	AO-30	30"	G4, G45, G46	533.50	
Charred American Oak See-thru	CHAO-2-18	18"	G4, G45, G46	479.50	
Charred American Oak See-thru	CHAO-2-24	24"	G4, G45, G46	551.50	
Charred American Oak See-thru	CHAO-2-30	30"	G4, G45, G46	681.50	
Gnarled Split Oak	GSO-24	24"	G4, G45, G46	537.50	
Gnarled Split Oak	GSO-30	30"	G4, G45, G46	667.50	
Gnarled Split Oak	GSO-36	36"	G4, G45, G46	817.50	

 **Realfyre™** 
Gas Logs

Vented

Stocked items listed, additional items available. Please call with questions.

Style	Item #	Length	Compatible Burners	MSRP	
Charred Oak	CHD-16	16"	G4, G31, G45, G46	313.50	
Charred Oak	CHD-18	18"	G4, G31, G45, G46	346.50	
Charred Oak	CHD-24	24"	G4, G31, G45, G46	400.50	
Charred Oak	CHD-30	30"	G4, G31, G45, G46	518.50	
Charred Oak Stack	CHDS-18	18"	G4, G45, G46	344.50	
Charred Oak Stack	CHDS-24	24"	G4, G45, G46	398.50	
Charred Oak Stack	CHDS-30	30"	G4, G45, G46	485.50	
Charred Oak See-thru	CHD-2-18	18"	G4, G45, G46	404.50	
Charred Oak See-thru	CHD-2-24	24"	G4, G45, G46	467.50	
Charred Oak See-thru	CHD-2-30	30"	G4, G45, G46	586.50	

In-Stock Items Available within 24 hours or can be picked up from our warehouse!
Non-Stock items normally available within 7-10 Business Days
Additional Items Available ~ Check Manufacturer Pricelists





Realfyre™ Gas Logs

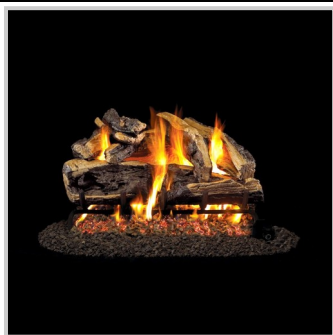

Vented

Stocked items listed, additional items available. Please call with questions.

Style	Item #	Length	Compatible Burners	MSRP	
Charred Rugged Split Oak	CHRRSO-18	18"	G4, G45, G46	392.50	
Charred Rugged Split Oak	CHRRSO-24	24"	G4, G45, G46	441.50	
Charred Rugged Split Oak	CHRRSO-30	30"	G4, G45, G46	555.50	
Charred Red Oak	CHRED-18	18"	G4, G45, G46	420.50	
Charred Red Oak	CHRED-24	24"	G4, G45, G46	475.50	
Charred Red Oak	CHRED-30	30"	G4, G45, G46	592.50	
Rugged Split Oak	RRSO-18	18"	G4, G45, G46	366.50	
Rugged Split Oak	RRSO-24	24"	G4, G45, G46	412.50	
Rugged Split Oak	RRSO-30	30"	G4, G45, G46	491.50	

In-Stock Items Available within 24 hours or can be picked up from our warehouse!
 Non-Stock items normally available within 7-10 Business Days
 Additional Items Available ~ Check Manufacturer Pricelists

realfyre **Realfyre™** **realfyre**
Gas Logs

Vented

Stocked items listed, additional items available. Please call with questions.

Style	Item #	Length	Compatible Burners	MSRP	
Golden Oak Designer Plus	RDP-12	12"	G4, G45, G46	235.50	
Golden Oak Designer Plus	RDP-16	16"	G4, G45, G46	251.50	
Golden Oak Designer Plus	RDP-18	18"	G4, G45, G46	291.50	
Golden Oak Designer Plus	RDP-24	24"	G4, G45, G46	347.50	
Golden Oak Designer Plus	RDP-30	30"	G4, G45, G46	451.50	
Charred Majestic Oak	CHMJ-24	24"	G4, G45	560.50	
Charred Majestic Oak	CHMJ-30	30"	G4, G45	704.50	
Charred Grizzly Oak	CHGO-24	24"	G4, G45	483.50	
Charred Grizzly Oak	CHGO-30	30"	G4, G45	654.50	
Charred Grizzly Oak	CHGO-36	36"	G4, G45	801.50	

In-Stock Items Available within 24 hours or can be picked up from our warehouse!
Non-Stock items normally available within 7-10 Business Days
Additional Items Available ~ Check Manufacturer Pricelists

realfyre **Realfyre™** **Gas Logs** **realfyre**

Vented

Stocked items listed, additional items available. Please call with questions.



Style	Item #	Length	Compatible Burners	MSRP	
Golden Oak	R-12	12"	G4, G45, G46	173.50	
Golden Oak	R-16	16"	G4, G45, G46	184.50	
Golden Oak	R-18	18"	G4, G45, G46	200.50	
Golden Oak	R-20	20"	G4, G45, G46	207.50	
Golden Oak	R-24	24"	G4, G45, G46	218.50	
Golden Oak	R-30	30"	G4, G45, G46	259.50	
Mountain White Birch	MBW-18	18"	G4, G45, G46	363.50	
Mountain White Birch	MBW-24	24"	G4, G45, G46	407.50	
Mountain White Birch	MBW-30	30"	G4, G45, G46	477.50	
Burnt Split Oak	HCHS-18/20	18"	G4, G45, G46	370.50	
Burnt Split Oak	HCHS-24	24"	G4, G45, G46	422.50	
Burnt Split Oak	HCHS-30	30"	G4, G45, G46	546.50	

In-Stock Items Available within 24 hours or can be picked up from our warehouse!
 Non-Stock items normally available within 7-10 Business Days
 Additional Items Available ~ Check Manufacturer Pricelists

realfyre **Realfyre™** **realfyre**
Gas Logs

Vented

Stocked items listed, additional items available. Please call with questions.

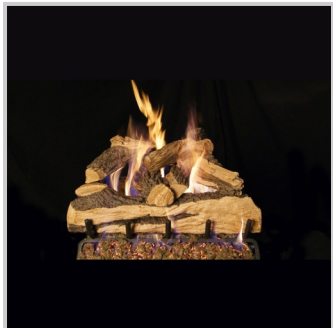
Style	Item #	Length	Compatible Burners	MSRP	
Charred Split Oak	CHS-18	18"	G4, G31, G45, G46	370.50	
Charred Split Oak	CHS-24	24"	G4, G31, G45, G46	422.50	
Charred Split Oak	CHS-30	30"	G4, G31, G45, G46	546.50	
White Birch	W-18	18"	G4, G45, G46	317.50	
White Birch	W-24	24"	G4, G45, G46	350.50	
White Birch	W-30	30"	G4, G45, G46	415.50	
Split Oak Designer Plus	SDP-18	18"	G4, G45, G46	342.50	
Split Oak Designer Plus	SDP-20	20"	G4, G45, G46	366.50	
Split Oak Designer Plus	SDP-24	24"	G4, G45, G46	395.50	
Split Oak Designer Plus	SDP-30	30"	G4, G45, G46	497.50	
Split Oak Designer Plus	SDP-36	36"	G4, G45, G46	643.50	

In-Stock Items Available within 24 hours or can be picked up from our warehouse!
Non-Stock items normally available within 7-10 Business Days
Additional Items Available ~ Check Manufacturer Pricelists

realfyre **Realfyre™** **realfyre**
Gas Logs

Vented

Stocked items listed, additional items available. Please call with questions.

Style	Item #	Length	Compatible Burners	MSRP	
Burnt Rustic Oak	HCHR-16	16"	G4, G45, G46	313.50	
Burnt Rustic Oak	HCHR-18/20	18/20"	G4, G45, G46	346.50	
Burnt Rustic Oak	HCHR-24	24"	G4, G45, G46	400.50	
Burnt Rustic Oak	HCHR-30	30"	G4, G45, G46	518.50	
Charred Mountain Birch	CHMBW-18/20	18/20"	G4, G45, G46	407.50	
Charred Mountain Birch	CHMBW-24	24"	G4, G45, G46	457.50	
Charred Mountain Birch	CHMBW-30	30"	G4, G45, G46	567.50	
Charred Forrest Oak	CHF-18/20	18/20"	G4, G45, G46	397.50	
Charred Forrest Oak	CHF-24	24"	G4, G45, G46	453.50	
Charred Forrest Oak	CHF-30	30"	G4, G45, G46	573.50	

In-Stock Items Available within 24 hours or can be picked up from our warehouse!
Non-Stock items normally available within 7-10 Business Days
Additional Items Available ~ Check Manufacturer Pricelists





Realfyre™ Gas Logs



Vented

Stocked items listed, additional items available. Please call with questions.



Style	Item #	Length	Compatible Burners	MSRP	<i>Italicized items are non-stock and are for ease of reference</i>
Charred Northern	CHN-18/20	18/20"	G4, G45, G46	358.50	
Charred Northern	CHN-24	24"	G4, G45, G46	415.50	
Charred Northern	CHN-30	30"	G4, G45, G46	533.50	
Charred Royal English Oak	CHB-18/20	18/20"	G31, G4, G45, P Series	420.50	
Charred Royal English Oak	CHB-24	24"	G31, G4, G45, P Series	494.50	
Charred Royal English Oak	CHB-30	30"	G31, G4, G45, P Series	616.50	
Charred Royal English Oak	CHB-36	36"	G31, G4, G45, P Series	775.50	
Pioneer Oak	PN-24	24"	G4, G45, P Series	481.50	
Pioneer Oak	PN-30	30"	G4, G45, P Series	612.50	
<i>Pioneer Oak</i>	<i>PN-36</i>	<i>36"</i>	<i>G4, G45, P Series</i>	<i>754.50</i>	

In-Stock Items Available within 24 hours or can be picked up from our warehouse!
 Non-Stock items normally available within 7-10 Business Days
 Additional Items Available ~ Check Manufacturer Pricelists

realfyre **Realfyre™** **Gas Logs** **realfyre**

Vented

Stocked items listed, additional items available. Please call with questions.

Style	Item #	Length	Compatible Burners	MSRP	
Charred Angel Split Oak	CHNS-18/20	18/20"	G31, G4, G45, G46	388.50	
Charred Angel Split Oak	CHNS-24	24"	G31, G4, G45, G46	435.50	
Charred Angel Split Oak	CHNS-30	30"	G31, G4, G45, G46	499.50	
Rustic Oak Designer	HRD-16	16"	G4, G45, G46	251.50	
Rustic Oak Designer	HRD-18	18"	G4, G45, G46	283.50	
Rustic Oak Designer	HRD-24	24"	G4, G45, G46	336.50	
Rustic Oak Designer	HRD-30	30"	G4, G45, G46	428.50	
Split Oak	S-18	18"	G4, G45, G46	308.50	
Split Oak	S-24	24"	G4, G45, G46	352.50	
Split Oak	S-30	30"	G4, G45, G46	450.50	

In-Stock Items Available within 24 hours or can be picked up from our warehouse!
 Non-Stock items normally available within 7-10 Business Days
 Additional Items Available ~ Check Manufacturer Pricelists







Realfyre™ Gas Logs



Vented

Stocked items listed, additional items available. Please call with questions.



Style	Item #	Length	Compatible Burners	MSRP	
Woodstack	WS-18	18"	G4, G45, G46	402.50	
Woodstack	WS-24	24"	G4, G45, G46	453.50	
Woodstack	WS-30	30"	G4, G45, G46	562.50	
Royal English Oak Designer	BD-18	18"	G31, G4, G45, P Series	384.50	
Royal English Oak Designer	BD-24	24"	G31, G4, G45, P Series	452.50	
Royal English Oak Designer	BD-30	30"	G31, G4, G45, P Series	556.50	
Woodland Oak	WO-18	18"	G4, G45, G46	284.50	
Woodland Oak	WO-24	24"	G4, G45, G46	324.50	
Western Campfyre	WCF-18	18"	G4, G45, G46	387.50	
Western Campfyre	WCF-24	24"	G4, G45, G46	446.50	

In-Stock Items Available within 24 hours or can be picked up from our warehouse!
 Non-Stock items normally available within 7-10 Business Days
 Additional Items Available ~ Check Manufacturer Pricelists

realfyre **Realfyre™** **realfyre**
Gas Logs

Vented

Stocked items listed, additional items available. Please call with questions.



Style	Item #	Length	Compatible Burners	MSRP	
Post Oak	PO-18	18"	G4, G45, G46	190.50	
Post Oak	PO-24	24"	G4, G45, G46	210.50	
Post Oak	PO-30	30"	G4, G45, G46	250.50	
Rustic Oak	HR-16	16"	G4, G45, G46	184.50	
Rustic Oak	HR-18	18"	G4, G45, G46	200.50	
Rustic Oak	HR-24	24"	G4, G45, G46	218.50	
Rustic Oak	HR-30	30"	G4, G45, G46	259.50	
Rugged Oak	RRO-18	18"	G4, G45, G46	241.50	
Rugged Oak	RRO-24	24"	G4, G45, G46	281.50	
Rugged Oak	RRO-30	30"	G4, G45, G46	334.50	

In-Stock Items Available within 24 hours or can be picked up from our warehouse!
Non-Stock items normally available within 7-10 Business Days
Additional Items Available ~ Check Manufacturer Pricelists

realfyre **Realfyre™** **realfyre**
Gas Logs

Vented

Stocked items listed, additional items available. Please call with questions.

Style	Item #	Length	Compatible Burners	MSRP	
Royal English Oak	B-18	18"	G4, G45, G46, P-Series	257.50	
Royal English Oak	B-24	24"	G4, G45, G46, P-Series	310.50	
Royal English Oak	B-30	30"	G4, G45, G46, P-Series	373.50	
Royal English Oak	B-36	36"	G4, G45, G46, P-Series	468.50	
Coastal Driftwood	CDR-18	18"	G31, G4, G45, P Series	216.50	
Coastal Driftwood	CDR-24	24"	G31, G4, G45, P Series	235.50	
Coastal Driftwood	CDR-30	30"	G31, G4, G45, P Series	280.50	
Coastal Driftwood	CDR-36	36"	G31, G4, G45, P Series	383.50	

www.FireplaceandChimneyAuthority.com

In-Stock Items Available within 24 hours or can be picked up from our warehouse!
Non-Stock items normally available within 7-10 Business Days
Additional Items Available ~ Check Manufacturer Pricelists



Realfyre™ Gas Burners Systems



For Vented Applications

G4 Series

Includes Custom Grate, Glowing Embers, Sand for NG or Vermiculite for LP, Flex Connector Kit, Burner Clips and Damper Clamp ~ G4 Series is available for NG or LP in 12"-60" Sets : LP version includes SPK-26 valve
Stocked items listed, additional items available. Please call with questions.

Fuel	Item #	Length	Burner	MSRP	
NG	G4-12Z	12"	Single w/ ember glow	212.50	
LP	G4-12P			359.50	
NG	G4-16Z	16"	Single w/ ember glow	227.50	
LP	G4-16P			374.50	
NG	G4-18/20Z	24"	Single w/ ember glow	234.50	
LP	G4-18/20P			381.50	
NG	G4-24Z	24"	Single w/ ember glow	241.50	
LP	G4-24P			388.50	
NG	G4-30Z	30"	Single w/ ember glow	277.50	
LP	G4-30P			424.50	
NG	G4-36Z	36"	Single w/ ember glow	380.50	

G45 Triple T Series

Includes Custom Grate, Glowing Embers, Sand for NG or Vermiculite for LP, Flex Connector Kit, Burner Clips and Damper Clamp
G45 Series is available for NG or LP in 12"-60" Sets : LP Version includes SPK-26 Valve ~
add "P" to end of part number and add \$145.00 to cost listed
Stocked items listed, additional items available. Please call with questions.

NG	G45-16/19Z	16"	Double w/ ember glow	263.50	
NG	G45-18/20Z	18"	Double w/ ember glow	270.50	
NG	G45-24Z	24"	Double w/ ember glow	290.50	
NG	G45-30Z	30"	Double w/ ember glow	333.50	
NG	G45-36Z	36"	Double w/ ember glow	442.50	

In-Stock Items Available within 24 hours or can be picked up from our warehouse!

Non-Stock items normally available within 7-10 Business Days

Additional Items Available ~ Check Manufacturer Pricelists



Realfyre™ Gas Burners Systems



For Vented Applications

G46 Series with Hidden Installed Controls

Includes Custom Grate, Glowing Embers, Sand for NG or Vermiculite for LP, Flex Connector Kit, Burner Clips and Damper Clamp ~G46 Series is available for NG or LP in 18"-30" Sets ~ Add "P" to end of part number
Stocked items listed, additional items available. Please call with questions.

Fuel	Item #	Length	Burner	MSRP	
NG	G46-18/20Z	18"	Single w/ ember glow	493.50	
NG	G46-24Z	24"		516.50	
NG	G46-30Z	30"		541.50	
NG	G46-18/20-15Z	18"	Single w/ Variable Remote	845.50	
NG	G46-24-15Z	24"		868.50	
NG	G46-30-15Z	30"		893.50	
NG	G46-18/20-02Z	18"	Single w/Electronic Variable Remote	903.50	
NG	G46-24-02Z	24"		926.50	
NG	G46-30-02Z	30"		951.50	

G31 3-Tiered Series

Includes Custom Grate, Glowing Embers, Sand for NG or Vermiculite for LP, Flex Connector Kit, Burner Clips and Damper Clamp ~ G31 Series is available for NG or LP in 18"-39" Sets
Stocked items listed, additional items available. Please call with questions.

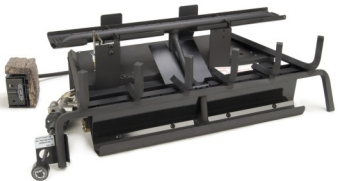
NG	G31-18/20	18"	3-Tier Manual	845.50	 <p>G31-24/30-17 Shown</p>
NG	G31-24/30	24"		884.50	
NG	G31-18/20-A	18"	3-Tier Standing Pilot	1029.50	
NG	G31-24/30-A	24"		1058.50	
NG	G31-18/20-17	18"	3-Tier Milivolt Variable Remote	1274.50	
NG	G31-24/30-17	24"		1310.50	
NG	G31-18/20-2VT	18"	3-Tier Electronic Variable Remote	1480.50	
NG	G31-24/30-2VT	24"		1519.50	



Realfyre™ Gas Logs



Dual Pan Burner Series

Fyre Spheres

4" or 5" spheres available in Epic Black and Graystone
Stocked items listed, additional items available. Please call with questions.

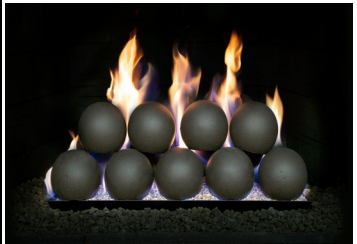
Size	Item#	Qty	Color	MSRP	
5"	FS5-18-EB	14	Epic Black	251.50	
5"	FS5-24-EB	19	Epic Black	327.50	
5"	FS5-30-EB	24	Epic Black	403.50	

P45 Dual Pan Burner Series - Designed to Give Contemporary A New Look!

Includes Sand, Vermiculite, Flex Connector Kit, Burner Clips and Damper Clamp ~ P45 Series is available for NG or LP in 18", 24" and 30" Use with Fyre Spheres Below Stocked items listed, additional items available. Please call with questions.

NG	P45-18	18"	Double	258.50	
NG	P45-24	24"	Double	276.50	
NG	P45-30	30"	Double	306.50	
NG	P45-18-17 variable valve/remote	18"	Double	700.50	
NG	P45-24-17 variable valve/remote	24"	Double	718.50	
NG	P45-30-17 variable valve/remote	30"	Double	748.50	



Realfyre™ Gas Logs



Dual Pan Burner Series

Shoreline Designer Oak

Designed Especially for the P45 pan burner

Style	Item #	Length	Compatible Burners	MSRP	
Shoreline Designer Oak - 10 Pcs	SO-18	18	P45	308.50	
Shoreline Designer Oak - 12 Pcs	SO-24	24	P45	344.50	
Shoreline Designer Oak - 15 Pcs	SO-30	30	P45	433.50	

Shoreline Driftwood

Designed Especially for the P45 pan burner ~ Items below are non-stock

Style	Item #	Length	Compatible Burners	MSRP	
Shoreline Driftwood - 10 Pcs	SDW-18	18	P45	229.50	
Shoreline Driftwood - 12 Pcs	SDW-24	24	P45	253.50	
Shoreline Driftwood - 15 Pcs	SDW-30	30	P45	310.50	

In-Stock Items Available within 24 hours or can be picked up from our warehouse!

Non-Stock items normally available within 7-10 Business Days

Additional Items Available ~ Check Manufacturer Pricelists





Realfyre™ Gas Logs



Vented See-Thru Systems

Stocked items listed, additional items available. Please call with questions.

Style	Item #	Length	Compatible Burners	MSRP	
Charred American Oak See-thru	CHAO-2-18	18"	G4, G45, G46	479.50	
Charred American Oak See-thru	CHAO-2-24	24"	G4, G45, G46	551.50	
Charred American Oak See-thru	CHAO-2-30	30"	G4, G45, G46	681.50	
Charred Oak See-thru	CHD-2-18	18"	G4, G45, G46	404.50	
Charred Oak See-thru	CHD-2-24	24"	G4, G45, G46	467.50	
Charred Oak See-thru	CHD-2-30	30"	G4, G45, G46	586.50	

G45 Triple T See-Thru Series

Includes Custom Grate, Glowing Embers, Sand for NG or Vermiculite for LP, Flex Connector Kit, Burner Clips and Damper Clamp
G45 Series is available for NG or LP in 12"-60" Sets: LP Version includes SPK-26 Valve ~
add "P" to end of part number and add \$145.00 to cost listed
Stocked items listed, additional items available. Please call with questions.

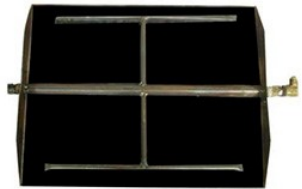
NG	G45-2-18/20Z	18"	Double w/ ember glow	310.50	
NG	G45-2-24Z	24"	Double w/ ember glow	331.50	
NG	G45-2-30Z	30"	Double w/ ember glow	380.50	

In-Stock Items Available within 24 hours or can be picked up from our warehouse!
Non-Stock items normally available within 7-10 Business Days
Additional Items Available ~ Check Manufacturer Pricelists



Realfyre™ Gas Logs



Radiant Fyre Systems

Stocked items listed, additional items available. Please call with questions.

Style	Item #	Length	Compatible Burners	MSRP	
Charred Evergreen Oak	ENO-18	18"	G52	455.50	
Charred Evergreen Oak	ENO-24	24"	G52	499.50	
Charred Evergreen Oak	ENO-30	30"	G52	588.50	
Colonial Oak	COLO-18	18"	G52	435.50	
Colonial Oak	COLO-24	24"	G52	474.50	
Colonial Oak	COLO-30	30"	G52	558.50	
Burnt Aspen	BTA-18	18"	G52	480.50	
Burnt Aspen	BTA-24	24"	G52	529.50	
Burnt Aspen	BTA-30	30"	G52	623.50	

G52 Radiant Fyre Burner - Match Lit

Includes Stainless Steel Booster, Custom Grate, Glowing Embers, Sand for NG or Vermiculite for LP, Flex Connector Kit, Burner Clips and Damper Clamp G52 Series is available for NG or LP in two sizes 18/20" and 24/30" Sets Stocked items listed, additional items available. Please call with questions.

Fuel	Item #	Length	Burner	MSRP	
NG	G52-18/20	18/20"	Single burner w/ stainless steel booster	597.50	
NG	G52-24/30	24/30"		646.50	
NG	G52-18/20-17	18/20"		1026.50	
NG	G52-24/30-17	24/30"		1075.50	
NG	G52-18/20-2VT	18/20"		1232.50	
NG	G52-24/30-2VT	24/30"		1281.50	

In-Stock Items Available within 24 hours or can be picked up from our warehouse!

Non-Stock items normally available within 7-10 Business Days

Additional Items Available ~ Check Manufacturer Pricelists





Realfyre™ Gas Logs



Vent Free Systems

Stocked items listed, additional items available. Please call with questions.

Style	Item #	Length	Compatible Burners	MSRP	
Evening Fyre	EFV-16/18	16/18"	G18	314.50	
Evening Fyre	EFV-24	24"	G18	352.50	
Evening Fyre	EFV-30	30"	G18	418.50	
Evening Fyre Charred	ECV-16/18	16/18"	G18	348.50	
Evening Fyre Charred	ECV-24	24"	G18	392.50	
Evening Fyre Charred	ECV-30	30"	G18	460.50	
Evening Fyre Split	ESV-16/18	16/18"	G18	340.50	
Evening Fyre Split	ESV-24	24"	G18	383.50	
Evening Fyre Split	ESV-30	30"	G18	448.50	

G18 Vent Free Burner

Includes Custom Grate, Bryte Coals, Two Decorative Wood Chunk Covers, Flex Connector Kit, Burner Clips and Damper Clamp

G18 Series is available for NG or LP in two sizes 18/20" and 24/30" Sets

Stocked items listed, additional items available. Please call with questions.

Fuel	Item #	Length	Burner	MSRP	
NG	G18-16/18	16/18"	Single burner w/ ember glow	678.50	
NG with on/off remote	G18-16/18-12	16/18"		923.50	
NG with variable remote	G18-16/18-15	16/18"		990.50	
NG with electronic remote	G18-16/18-01V	16/18"		1206.50	
NG	G18-24/30	24/30"		752.50	
NG with on/off remote	G18-24/30-12	24/30"		997.50	
NG with variable remote	G18-24/30-15	24/30"		1064.50	
NG with electronic remote	G18-24/30-01V	24/30"		1251.50	





Realfyre™ Gas Logs



Vent Free Systems

Stocked items listed, additional items available. Please call with questions.

Style	Item #	Length	Compatible Burners	MSRP	
Split Oak	S9-20	20"	G9	258.50	
Split Oak	S9-24	24"	G9	280.50	
Split Oak	S9-30	30"	G9	340.50	
Golden Oak Designer	RD9-20	20"	G9	242.50	
Golden Oak Designer	RD9-24	24"	G9	260.50	
Golden Oak Designer	RD9-30	30"	G9	318.50	

G9 Vent Free Burner

Includes Custom Grate, Bryte Coals, Lava Granules, Flex Connector Kit, Burner Clips and Damper Clamp
G9 Series is available for NG or LP in one (1) size covering three (3) sizes of logs
Stocked items listed, additional items available. Please call with questions.

Fuel	Item #	Length	Burner	MSRP	
NG	G9 20/24/30	20/24/30"	Single burner w/ ember glow	472.50	
NG with on/off remote	G9 20/24/30-12	20/24/30"	Single burner w/ ember glow	717.50	
NG with variable remote	G9 20/24/30-15	20/24/30"	Single burner w/ ember glow	784.50	

In-Stock Items Available within 24 hours or can be picked up from our warehouse!
Non-Stock items normally available within 7-10 Business Days
Additional Items Available ~ Check Manufacturer Pricelists





Realfyre™ Gas Logs



Vent Free Systems

Stocked items listed, additional items available. Please call with questions.

Style	Item #	Length	Compatible Burners	MSRP	
Foothill Split Oak	FTSO-18	18"	G19	348.50	
Foothill Split Oak	FTSO-24	24"	G19	389.50	
Foothill Split Oak	FTSO-30	30"	G19	461.50	
Foothill Oak	FTO-18	18"	G19	324.50	
Foothill Oak	FTO-24	24"	G19	359.50	
Foothill Oak	FTO-30	30"	G19	426.50	

G19 Vent Free Burner

Includes Custom Grate, Lava Granules, Flex Connector Kit, Burner Clips and Damper Clamp
G19 Series is available for NG or LP in two sizes 18/20" and 24/30" Sets
Stocked items listed, additional items available. Please call with questions.

Fuel	Item #	Length	Burner	MSRP	
NG with on/off remote	G19 18/20-12	18/20"	Single burner w/ ember glow	926.50	
NG with variable remote	G19 18/20-15	18/20"	Single burner w/ ember glow	993.50	
NG with on/off remote	G19 24/30-12	24/30"	Single burner w/ ember glow	976.50	
NG with variable remote	G19 24/30-15	24/30"	Single burner w/ ember glow	1043.50	

In-Stock Items Available within 24 hours or can be picked up from our warehouse!
Non-Stock items normally available within 7-10 Business Days
Additional Items Available ~ Check Manufacturer Pricelists



Realfyre™ Gas Logs



Vent Free Systems

Stocked items listed, additional items available. Please call with questions.

Style	Item #	Length	Compatible Burners	MSRP	
Valley Oak	VO8E-16	16"	G8E	252.50	
Valley Oak	VO8E-18	18"	G8E	281.50	
Valley Oak	VO8E-20	20"	G8E	309.50	

G8E Vent Free Burner

Includes Custom Grate, Decorative Front Panel, ODS Safety System, Flex Connector Kit, Burner Clips and Damper Clamp
G8E Series is available for NG or LP in one (1) size covering three (3) sizes of logs
Stocked items listed, additional items available. Please call with questions.

Fuel	Item #	Length	Burner	MSRP	
NG	G8E-16/20/24	16/20/24"	Single burner	350.50	
NG with on/off remote	G8E-16/20/24-12	16/20/24"	Single burner	595.50	

In-Stock Items Available within 24 hours or can be picked up from our warehouse!
Non-Stock items normally available within 7-10 Business Days
Additional Items Available ~ Check Manufacturer Pricelists





Realfyre™ Gas Logs

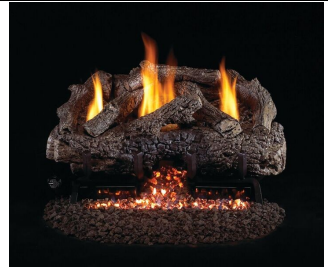

Vent Free Systems

Stocked items listed, additional items available. Please call with questions.

Style	Item #	Length	Compatible Burners	MSRP	
Charred Frontier Oak	CHFR-16/18	16/18"	G10	298.50	
Charred Frontier Oak	CHFR-24	24"	G10	335.50	
Charred Frontier Oak	CHFR-30	30"	G10	409.50	
Charred Aged Split	CHAS-16/18	16/18"	G10	324.50	
Charred Aged Split	CHAS-24	24"	G10	366.50	
Charred Aged Split	CHAS-30	30"	G10	441.50	

G10 Vent Free Burner

Includes Custom Grate, Lava Granules, Flex Connector Kit, Burner Clips and Damper Clamp
G10 Series is available for NG or LP in two sizes 16/18" and 24/30" Sets
Stocked items listed, additional items available. Please call with questions.

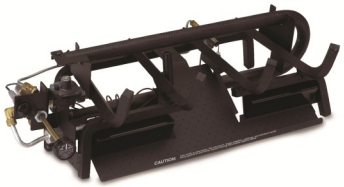
Fuel	Item #	Length	Burner	MSRP	
NG	G10-16/18	16/18"	Single burner w/ ember glow	614.50	
NG with on/off remote	G10-16/18-12	16/18"	Single burner w/ ember glow	859.50	
NG with variable remote	G10-16/18-15	16/18"	Single burner w/ ember glow	926.50	
NG	G10-24/30	24/30"	Single burner w/ ember glow	681.50	
NG with on/off remote	G10-24/30-12	24/30"	Single burner w/ ember glow	926.50	
NG with variable remote	G10-24/30-15	24/30"	Single burner w/ ember glow	993.50	

In-Stock Items Available within 24 hours or can be picked up from our warehouse!

Non-Stock items normally available within 7-10 Business Days

Additional Items Available ~ Check Manufacturer Pricelists





Realfyre™ Gas Logs



Fyreside Builders Series Logs

Stocked items listed, additional items available. Please call with questions.

Style	Item #	Length	Venting	MSRP	
Live Oak Vented	68-YE	18"	Vented	301.95	
Live Oak Vented	64-YE	24"	Vented	337.65	
Live Oak Vented	63-YE	30"	Vented	391.20	
Live Oak Vent Free	71-VF9	21"	Vent-Free	610.50	
Live Oak Vent Free	74-VF9	24"	Vent-Free	646.20	
Live Oak Vent Free	73-VF9	30"	Vent-Free	689.55	

Realfyre Parts / Valves / Remotes

Item #	Description	MSRP
TH-1	Thermocouple	19.00
VR-1A	Standard Variable Remote	105.00
VR-2A	Deluxe Variable Remote	144.00
RR-1A	Standard On/Off Remote	87.00
RR-2A	Deluxe Basic Remote	127.00
PAC-1NAT	Pilot & Bracket Assembly	35.00
PAC-2NAT	Pilot Assembly Complete	67.00
PAC-6	Pilot Assembly	81.00
PAC-7	Pilot Assembly	81.00
ODS-0001	Oxygen Depletion Sensor NG	49.00
ODS-0003	Oxygen Depletion Sensor NGMV	94.00
SPK-26	Safety Pilot Kit (Low Profile)	147.00
AV-18	On/Off Valve With Extension Knob	53.00
APK-10	Automatic Pilot Kit w/ basic remote	622.00
APK-15	Automatic Pilot Kit w/ basic remote, variable flame	499.00
APK-17	Automatic Pilot Kit w/ basic remote, variable flame	401.00
EPK-1	Electronic Pilot Kit w/ basic remote, non-standing pilot	547.00
EPK-2	Electronic Pilot Kit w/ basic remote, non-standing pilot/low-profile valve	530.00
DC-1	Damper Clamp w/ Bolt	11.00



AMERICAN HEARTH

American Hearth Vent Free Slope Glaze Burners



AMERICAN HEARTH

FEATURES:

- Available in IP or Millivolt
- P available in three (3) sizes
- IP includes Thermostatic Remote, MV is on/off ready
- MV available in four (4) sizes
- **Requires Purchase of Log Set (see next page)**

Item #	Description	MSRP
IP Control		
VFSE18N	IP, Variable Remote, 18-in NG	1136.50
VFSE18P	IP, Variable Remote, 18-in LP	1136.50
VFSE24N	IP, Variable Remote, 24-in NG	1156.50
VFSE24P	IP, Variable Remote, 24-in LP	1156.50
VFSE30N	IP, Variable Remote, 30-in NG	1186.50
VFSE30P	IP, Variable Remote, 30-in LP	1186.50
Millivolt Control		
VFSR16NAT	MV, On/Off Switch, 16-in NG Remote Ready	746.50
VFSR16LP	MV, On/Off Switch, 16-in LP Remote Ready	746.50
VFSR18NAT	MV, On/Off Switch, 18-in NG Remote Ready	756.50
VFSR18LP	MV, On/Off Switch, 18-in LP Remote Ready	756.50
VFSR24NAT	MV, On/Off Switch, 24-in NG Remote Ready	796.50
VFSR24LP	MV, On/Off Switch, 24-in LP Remote Ready	796.50
VFSR30NAT	MV, On/Off Switch, 30-in NG Remote Ready	866.50
VFSR30LP	MV, On/Off Switch, 30-in LP Remote Ready	866.50
Accessories		
FRBC	Battery Operated On/Off Remote	144.00
FRBTC	Battery Operated Thermostatic Remote	254.00

Above Burners MUST Be Used with The Appropriate Log Set On Next Page

www.FireplaceandChimneyAuthority.com



Refractory Log Sets

FEATURES:

- Provides Consistent Controlled Heat
- 3 Styles from Which to Choose
- Designed to complement the burner pattern
- Uses about half the energy of a vented system
- **Requires Purchase of Slope Glaze Burner (see previous page)**

Item #	Description	MSRP
American Hearth Charleston Log Set		
ALS16CR1	6-piece, 16" Refractory Log set	109.00
ALS18CR1	6-piece, 18" Refractory Log set	129.00
ALS24CR1	6-piece, 24" Refractory Log set	154.00
ALS30CR1	6-piece, 30" Refractory Log set	279.00
American Hearth Williamsburg Log Set		
ALS18CR2	13-piece, 18" Refractory Log set	239.00
ALS24CR2	13-piece, 24" Refractory Log set	284.00
ALS30CR2	13-piece, 30" Refractory Log set	329.00
American Hearth Ravenwood Log Set		
ALS18RV	8-piece, 18" Refractory Log set	174.00
ALS24RV	8-piece, 24" Refractory Log set	199.00
ALS30RV	8-piece, 30" Refractory Log set	224.00
White Mountain Hearth Birch Log Set		
LS-18B2	4-piece, 18" Ceramic Fiber Log set	124.00
LS-24B2	4-piece, 24" Ceramic Fiber Log set	144.00
LS-30B2	4-piece, 30" Ceramic Fiber Log set	169.00
White Mountain Hearth Sassafras Log Set		
LS-18RS	6-piece, 18" Refractory Log set	144.00
LS-24RS	6-piece, 24" Refractory Log set	179.00
LS-30RS	6-piece, 30" Refractory Log set	204.00
White Mountain Hearth Sassafras Log Super Set		
LS-18RSS	7-piece, 18" Refractory Log set	239.00
LS-24RSS	7-piece, 24" Refractory Log set	289.00
LS-30RSS	7-piece, 30" Refractory Log set	324.00
<i>Above Log Sets Must Be Used with The Appropriate Burner On Previous Page</i>		

Special Order Items Highlighted

www.FireplaceandChimneyAuthority.com

realfyre **realfyre**

Realfyre™ Specialty Gas Burners Systems

Stocked items listed, additional items available. Please call with questions.

Style	Item #	Length	Burner	MSRP	
G45 Stainless Steel "Triple T" Series - Ideal for Outdoor Applications					
Includes Custom Grate, Glowing Embers, Sand for NG or Vermiculite for LP, Flex Connector Kit, Burner Clips and Damper Clamp G45 Series is available for NG or LP in 12"-60" Sets ~ Stocked items listed, additional items available. Please call with questions.					
NG	G45-24Z-SS	24"	Double w/ ember glow	362.50	
NG	G45-30Z-SS	30"	Double w/ ember glow	411.50	

G21 Contemporary Burner Series ~ Stainless Steel and Includes On-Off Remote					
G21 Series is available for NG or LP in 18", 24" and 30" Sets — Find the perfect fill material in our Fireglass Section of our catalog.					
NG	G21-GL-18-12	18" req. 7.5 lbs of glass	Stainless Steel w/ on-off remote	1042.50	 Glass not included
NG	G21-GL-24-12	24" req. 10 lbs of glass	Stainless Steel w/ on-off remote	1122.50	
NG	G21-GL-30-12	30" req. 15 lbs of glass	Stainless Steel w/ on-off remote	1167.50	

P45 Dual Pan Burner Series - Designed to Give Contemporary A New Look!					
Includes Sand, Vermiculite, Flex Connector Kit, Burner Clips and Damper Clamp ~ P45 Series is available for NG or LP in 18", 24" and 30" Use with Fyre Spheres Below Stocked items listed, additional items available. Please call with questions.					
NG	P45-18	18"	Double	258.50	
NG	P45-24	24"	Double	276.50	
NG	P45-30	30"	Double	306.50	
NG	P45-18-17 variable valve/remote	18"	Double	700.50	
NG	P45-24-17 variable valve/remote	24"	Double	718.50	
NG	P45-30-17 variable valve/remote	30"	Double	748.50	

Fyre Spheres

4" or 5" spheres available in Epic Black and Graystone
Stocked items listed, additional items available. Please call with questions.

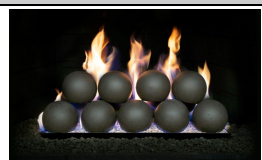
Size	Item#	Qty	Color	MSRP	
5"	FS5-18-EB	14	Epic Black	251.50	
5"	FS5-24-EB	19	Epic Black	327.50	
5"	FS5-30-EB	24	Epic Black	403.50	

In-Stock Items Available within 24 hours or can be picked up from our warehouse!
Non-Stock items normally available within 7-10 Business Days
Additional Items Available ~ Check Manufacturer Pricelists

Accessories





Stocked items listed, additional items available. Please call with questions.

Item #	Description	MSRP	
EM-1	Ember Glow	24.99	
EM-10 (disc item, limited stock)	Vent Free Ember Glow	20.00	
EM-11	Bryte Coals	22.00	
EM-1S	Super Embers	38.00	
EB-1	Black Embers	29.99	
LF-15	Vermiculite	23.00	
LF-10	10-lb Lava Fyre Granules	30.00	
LF-5	5-lb Lava Fyre Granules	17.00	
CS-10	10-lb Select White Sand	24.99	
PC-4	4 Assorted Mixed Designer Pinecones	40.00	
AC-6	6 Acorns	34.00	
PCDC-1	Decorative Pinecone Cover	40.00	
PCC-1	Pinecone Crackler	118.00	
DP-2	4 Wood Chips and 3 Pinecones	53.00	
WC-6	6 Wood Chips	47.00	
WCH-6	6 Charred Wood Chips	52.00	
WCRD-1	Wood Chip Ring	33.00	
WCDC-1	Wood Chunk Decorative Cover	40.00	
BDC-4	Four Charred Branches	91.00	
STN-10	River Rock Fyrestones-Assorted	107.00	
STN-10I	River Rock Fyrestones-Ivory	107.00	
STN-10S	River Rock Fyrestones-Slate	107.00	
STN-10T	River Rock Fyrestones-Terracotta	107.00	
FF-04-18	Cast Iron Fender, 18"	51.00	
FF-04-24	Cast Iron Fender, 24"	59.00	
FF-04-30	Cast Iron Fender, 30"	72.00	
GLD-10-DB	Deep Black Diamond Nuggets	69.00	
GLD-10-BL	Black Luster Diamond Nuggets	69.00	

 **Realfyre™** 
Accessories & Fyrebacks

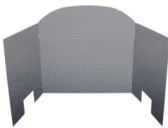
Fyrebacks

Stocked items listed, additional items available. Please call with questions.

Item #	Width	Description	MSRP	
FBS-18	18"	Traditional Satin Stainless Steel	126.00	
FBS-24	24"	Traditional Satin Stainless Steel	144.00	
FBS-30	30"	Traditional Satin Stainless Steel	158.00	
FBCP-18	18"	Contemporary Polished Stainless Steel	195.00	
FBCP-24	24"	Contemporary Polished Stainless Steel	209.00	
FBCP-30	30"	Contemporary Polished Stainless Steel	233.00	
FBSP-18	18"	Traditional Polished Stainless Steel	195.00	
FBSP-24	24"	Traditional Polished Stainless Steel	209.00	
FBCB-18	18"	Contemporary Black Porcelain	195.00	
FBCB-24	24"	Contemporary Black Porcelain	209.00	
FBCB-30	30"	Contemporary Black Porcelain	233.00	
FBSB-18	18"	Traditional Black Porcelain	195.00	
FBSB-24	24"	Traditional Black Porcelain	209.00	

 **Skamolex™ Design Panels** 

Item #	Dimensions	Description	Retail Price	<i>*Installed Price add \$150.00</i>
620100	24" H x 39" W x 1" D (5/8" at mortar)	Standard Brick, 2012°F Panel	132.00*	
620101	24" H x 39" W x 1" D (5/8" at mortar)	Herringbone Brick, 2012°F Panel	132.00*	

 **American Hearth Remote Controls** 

Item #	Description	MSRP	
FRBC	Standard On/Off Remote	144.00	
FRBTC	Thermostatic Remote Control	254.00	
RVKN	Remote Kit, Variable Flame	259.00	

Dimplex

Open Hearth Insert

Dimplex

LED Flame Technology

A blend of technology, artistry and craftsmanship, the patented LED Dimplex flame technology creates the illusion of a true fire.

LED Inner Glow Logs

Patented LED inner glow logs and pulsating ember technology allow the logs and embers to glow in concert creating an unmatched realistic fireplace experience.

Safe

With no flame heat or emission our fireplaces inserts are the safe choice for your home.

Realistic Log Set

Dimplex fireplace logs are hand crafted and molded from real wood logs, offering an incredibly realistic log set.

Item #	Description	MSRP
DLG1058	28" Open Hearth Insert - Bring an unused fireplace back to life with the Dimplex open hearth insert. The projected dancing flame effect combined with hand finished logs showcasing our patented LED inner glow technology creates an authentic fireplace experience without the mess.	683.00



Dimplex

23" Electric Insert

Dimplex

Supplemental Heat

Includes a powerful fan-forced heater designed to heat a room up to 400 square feet, providing supplemental heat when required.

Year-round Comfort

Enjoy the ambiance of the flame with or without the heater for year-round comfort and enjoyment

Safe

With no flame heat or emission our fireplaces inserts are the safe choice for your home.

Green

The green alternative. No harmful particulates or emissions and 100% efficient.

Deluxe Includes Inner Glow Logs

Patented LED inner glow logs and pulsating ember technology allow the logs and embers to glow in concert creating an unmatched realistic fireplace experience.



DFI2310

Item #	Description	MSRP
DFI2309 Standard	Reclaim the charm and warmth of your old useless fireplace, with this elegant and functional electric insert. Offering meticulously handcrafted logs along with gently glowing embers that mimic the real thing. Specifically designed to easily fit into many existing wood fireplace openings, this sophisticated electric insert brings new life to any room without the dangers of open flames, wood or propane.	263.00
DFI2310 Deluxe		368.00
DFI23TRIMX	Expandable Trim Kit for DFI2309 and DFI2310 Includes trim, spark screen and hardware	242.00

Dimplex

Opti-Myst Fireplace Cassette Insert

Dimplex

Flame Technology

The Opti-myst uses revolutionary ultrasonic technology to create a lifelike flame and smoke effect. The result is an appearance so authentic it will be mistaken for a traditional wood-burning fireplace.

It's not gas. It's water.

As mist rises up through the media bed, light reflects against the water molecules creating a convincing illusion of flames and smoke. Each unit comes equipped with an easy to fill water tank which offers 12 to 14 hours of continuous operation before refilling.

Safe

100% safe with cool flames and no emissions. The perfect way to have a worry-free 360° flame experience.

Media Consoles and Mantels

Exquisitely designed with premium grade finishes and patented flame technology.

Versatility

Use in any space large or small, including bedrooms, bathrooms, foyers and more.

Cassettes and Inserts

A full line of Opti-myst plug-in cassettes and inserts, perfect for custom applications, as well as the new line of Opti-myst Pro direct-wire models for use in seamless built-in designs.

DFI400C



DLGM29

www.FireplaceandChimneyAuthority.com



Opti-Myst Fireplace
Cassette Insert

FEATURES:

- On/Off Remote
- Heat-free Operation
- All Season Flames
- Zero Emissions
- Easy Fill Water Tank
- Plugs into Any Standard Outlet
- Energy Efficient
- LED Lighting

Ideal for Commercial Installations as well ~ Reduces Liabilities and meets strictest building codes

Item #	Description	MSRP
Available Cassette Models		
DFI400CH	Opti-Myst Cassette with Heat Receptacle (with curved black tray) - 400mm insert with revolutionary ultrasonic technology to create the flame and smoke effect. Includes remote control. Does not include a heater. Ships in one carton	1158.00
Fireplace Cassette Insert Model		
DLGM29	Opti-Myst II Insert - Revolutionary ultrasonic technology to create the flame and smoke effect. Features hand finished Logs with natural inner glow, pulsating embers and metal Log grate. Includes on/off remote control. Does not include heat. Ships in one carton.	893.00
Accessories		
CDFIPLUMB-KIT	Plumbing kit for Opti-myst Pro 500mm/1000mm Cassette - Optional plumbing kit allows for continuous water supply, eliminating the need to fill water reservoirs. Complete with an overflow safety sensor, automatically shuts off the water supply to prevent any leaks. Ships in 1 carton.	72.00
RB400	Halogen Bulbs for Opti-Myst, Four Pack	44.00

Special Order Items Highlighted

www.FireplaceandChimneyAuthority.com



Dimplex

Revillusion Insert

Dimplex

<p>Revillusion™ Flame Technology Flames are larger, brighter and more random, appearing from within the logs.</p>	<p>Mirage Flame Panel Partially frosted acrylic panel is clearly better than a mirror, showing only dazzling flames and no reflections.</p>
<p>ThruView™ Full-depth Design See clear through the flames to the back of a masonry fireplace for a more authentic experience.</p>	<p>360° Light Add flickering light to enhance the firelight feature</p>
<p>Color Enhancement Adjust the flame base color to red or blue</p>	<p>Realogs™ Plus A full grate of life-size hardwood-cast logs, tiered for greater depth.</p>
<p>Brightness Adjusts light level to suit the room</p>	<p>Heat on Demand Enjoy the heater without the flames to warm up your room.</p>
<p>Hidden Heat Fan-forced ceramic heater provides perfect comfort for small spaces</p>	<p>Just Plug It In Simply plug into any standard household outlet for instant ambiance.</p>

Item #	Description	MSRP
RLG20	20" Revillusion Masonry fireplace log set with Revillusion flame technology, Mirage flame panel, ThruView full-depth design, mood lighting and Realogs, 1,500 W/120 V. Includes multi-function remote control. Optional ember mat (model number REM-KIT) sold separately. Ships in two carton.	263.00
RLG25	25" Revillusion Masonry fireplace log set with Revillusion flame technology, Mirage ember mat (model number REM-KIT) included. Ships in one carton.	473.00
REM-KIT	Optional ember mat (model number REM-KIT) for RLG20 sold separately. Ships in one carton.	74.00

www.FireplaceandChimneyAuthority.com

*Revillusion™ is a completely new way of looking at fireplaces, and changing the standard for electric. A clear view through the lifelike flames, to the full brick interior, captures the charm of a wood-burning fireplace. Enjoy the look of a fireplace cut straight from the pages of a magazine by choosing **Revillusion™**; clearly a better fireplace.*



RLG20

Optional Ember
Mat Available

RLG25





Dormont Gas Valves & Connectors



Valves

Stocked items listed, additional items available. Please call with questions.

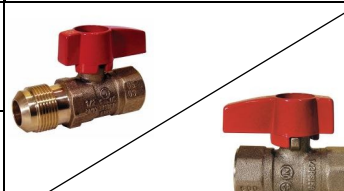
Size	Item #	Length	LP/NG	Retail Price	
1/2 IN OD Flare x 1/2 IN FIP Gas Connector Shutoff Valve	91-2032	—	Both	10.99	
1/2 IN FIP x 1/2 IN FIP Straight Gas Shutoff Valve	92-3232	—	Both	9.99	

Connectors

Stocked items listed, additional items available. Please call with questions.

Size	Item #	Length	LP/NG	Retail Price	
1/2 IN OD, 3/8 IN ID, Stainless Steel Gas Connector, 1/2 IN MIP x 1/2 IN FIP Black Whisper Flex	20ANW-3132-12	12"	Both	34.99	
1/2 IN OD, 3/8 IN ID, Stainless Steel Gas Connector, 1/2 IN MIP x 1/2 IN FIP Black Whisper Flex	20ANW-3132-18	18"	Both	41.99	
1/2 IN OD, 3/8 IN ID, Stainless Steel Gas Connector, 1/2 IN MIP x 1/2 IN FIP Black Whisper Flex	20ANW-3132-24	24"	Both	47.99	
3/8" MIP x 1/2" FIP x 24"L Black Whisper Flex	10ANW-3132-18	18"	Both	32.99	
3/8 IN OD, 1/4 IN ID, Stainless Steel Gas Connector, 3/8 IN MIP x 1/2 IN FIP Black Whisper Flex	10ANW-2132-24	24"	Both	37.99	
3/8 IN OD, 1/4 IN ID, Stainless Steel Gas Connector, 1/2 IN MIP x 1/2 IN FIP Black Whisper Flex	10ANW-3132-24	24"	Both	41.99	
1/2 IN OD, 3/8 IN ID, Stainless Steel Gas Connector, 1/2 IN MIP x 1/2 IN MIP	20-3131-48	48"	Both	44.99	
3/8 IN x 12 FT Portable Outdoor Gas Connector	20D-12QD	12'	Both	99.99	
1/2 IN x 12 FT Portable Outdoor Gas Connector	30D-12QD	12'	Both	89.99	

In-Stock Items Available within 24 hours or can be picked up from our warehouse!

Non-Stock items normally available within 7-10 Business Days

Additional Items Available ~ Check Manufacturer Pricelists

TracPipe Underground Flexible Gas Line

Item #	Description	MSRP
FGP-UGP-500-100	TracPipe PS-II 1/2" 100 Ft. Reel	922.00 / rl
FGP-UGP-500-250	TracPipe PS-II 1/2" 250 Ft. Reel	2305.00 / rl
FGP-UGP-500-250-01	TracPipe PS-II 1/2" 1 Ft Increments	11.07 / ft
FGP-UGP-750-100	TracPipe PS-II 3/4" 100 Ft. Reel	1169.00 / rl
FGP-UGP-750-250	TracPipe PS-II 3/4" 250 Ft. Reel	2922.50 / rl
FGP-UGP-750-250-01	TracPipe PS-II 1/2" 1 Ft. Increments	14.03 / ft
FGP-UGF-500	TracPipe PS-II 1/2" Male Adapter	73.85
FGP-UGF-750	TracPipe PS-II 3/4" Male Adapter	88.89
FGP-TC-151	Tubing Cutter No. 151, 3/8" -- 1-1/4"	80.40
FGP-LCS	Non-Corrosive Leak Check Solution	27.18
FGP-915-10H-12BL	Black Connection Tape, 12 yd roll	56.35



FEATURES:

- Popular TracPipe System product enhanced with a flexible black jacket, vented fittings, and a yellow layline for underground/other applications
- Vented containment system for gas control safety
- Installs in a fraction of the time to other piping materials
- Extremely damage resistant
- Easy to handle
- Quick attachment fittings
- NPT connections
- Long lengths w/o joints
- Lower installation cost and shortened time
- **FLEXIBLE**

Applications:

- Under Buildings/Slab
- Rooftops
- Exterior walls
- Pool Heaters
- School Labs
- Barbecues
- Island Ranges
- Gas Lamps/Torches
- Stadiums

TracPipe can only be sold to certified installers. For a list of upcoming certification classes, call us at 630-241-0506. Have a large group? We can arrange to have the class brought to you!

Item #	Description	MSRP
Choose Firebox		
DVI-25i-11-33N	25" iSeries (IPI) Direct Vent Natural Gas	2230.00
DVI-25i-11-33P**	25" iSeries (IPI) Direct Vent Propane	2230.00
DVI-25m-01-32N	25" iSeries (Millivolt) Direct Vent Natural Gas	1800.00
DVI-25m-01-32P**	25" iSeries (Millivolt) Direct Vent Propane	1800.00
Choose Log Set (1 required)		
DVL-25-2A	Burnt American Oak	325.00
DVL-25-2S**	Burnt Split American Oak	350.00
DVL-25-2CO	Charred Ancient Oak	350.00
DVL-25-2CR	Charred Rustic Oak	350.00
DVL-25-2MB	Charred Mountain Birch	375.00
Choose Liner (1 required)		
DVP-25-1H	Herringbone Brick Firebox Liner	150.00
DVP-25-1B**	Boston Buff Traditional Brick Firebox Liner	150.00
DVP-25-1P	Black Porcelain Firebox Liner	175.00
Choose Surround (1 required) ~ includes hinged panel and mesh barrier screen		
DVS-25-3A	Small 3-Sided Surround	200.00
DVS-25-3B	Medium 3-Sided Surround	225.00
DVS-25-3C	Large 3-Sided Surround	250.00
DVS-25-4A**	Small 4-Sided Surround	225.00
DVS-25-4B**	Medium 4-Sided Surround	250.00
DVS-25-3CUS***	CUSTOM 3-Sided Surround	725.00
DVS-25-4CUS***	CUSTOM 4-Sided Surround	750.00
Choose Decorative Overlay (optional)		
DVO-25-3FG**	Frame Overlay Rose Gold	190.00
DVO-25-3FS	Frame Overlay Satin Stainless Steel	125.00
DVO-25-3FB	Frame Overlay Bronze	165.00
DVO-25-3MRB	Mission Overlay Black (w/ offset frame)	450.00
DVO-25-3MVI	Mission Overlay Vintage Iron (w/ offset frame)	450.00
DVO-25-3MSB	Mission Overlay Bronze (w/ offset frame)	450.00
DVO-25-3NB**	Nest Overlay Black (w/ offset frame)	375.00
DVO-25-3NS**	Nest Overlay Satin Stainless Steel (w/ offset frame)	450.00
Vent Kit		
4DVT33FK	Metal Fab Direct Vent Masonry Relining Kit (3x3)	395.30
** Non Stock Items Available for Order *** Custom Orders require order form to be submitted		

www.FireplaceandChimneyAuthority.com



Standard Features:

- Large Viewing Area
- Choice of NG or LP
- Specially crafted Real Fyre log sets
- High performance 125 CFM blower
- Electronic Ignition system with battery backup (iSeries)
- Accent lights highlights logs (iSeries)
- Choice of brick pattern for the look of masonry or black porcelain to reflect the flames
- Surrounds in 3-sided or 4-sided configurations
- Full function remote control to command flame and heat adjustments, thermostatic or timer operations as well as control the blower and light dimmer
- On/Off Remote with temperature display and thermostatic control function



Burnt American Oak

Burnt Split American Oak

Charred Mountain Birch

Charred Ancient Oak

Charred Rustic Oak



3-Sided Surround (Medium)



Herringbone



Traditional



Porcelain



4-Sided Surround (Medium)



Frame Overlay



Mission Overlay



Nest Overlay

In-Stock Items Available within 24 hours or can be picked up from our warehouse!
Non-Stock items normally available within 7-10 Business Days
Additional Items Available ~ Check Manufacturer Pricelists

RealFyre Direct Vent Gas Insert ~ 30-inch

Item #	Description	MSRP
Choose Firebox		
DVI-30i-11-33N	30" iSeries (IPI) Direct Vent Natural Gas	2550.00
DVI-30i-11-33P**	30" iSeries (IPI) Direct Vent Propane	2550.00
DVI-30m-01-32N	30" iSeries (Millivolt) Direct Vent Natural Gas	2100.00
DVI-30m-01-32P**	30" iSeries (Millivolt) Direct Vent Propane	2100.00
Choose Log Set (1 required)		
DVL-30-2A**	Burnt American Oak	375.00
DVL-30-2S	Burnt Split American Oak	400.00
DVL-30-2CO	Charred Ancient Oak	400.00
DVL-30-2CR**	Charred Rustic Oak	400.00
DVL-30-2MB	Charred Mountain Birch	425.00
Choose Liner (1 required)		
DVP-30-1H	Herringbone Brick Firebox Liner	175.00
DVP-30-1B	Boston Buff Traditional Brick Firebox Liner	175.00
DVP-30-1P	Black Porcelain Firebox Liner	200.00
Choose Surround (1 required) ~ includes hinged panel and mesh barrier screen		
DVS-30-3A	Small 3-Sided Surround	225.00
DVS-30-3B	Medium 3-Sided Surround	250.00
DVS-30-3C	Large 3-Sided Surround	275.00
DVS-30-4A**	Small 4-Sided Surround	250.00
DVS-30-4B**	Medium 4-Sided Surround	275.00
DVS-30-3CUS***	Custom 3-Sided Surround	750.00
DVS-30-4CUS***	Custom 4-Sided Surround	775.00
Choose Decorative Overlay (optional)		
DVO-30-3FG**	Frame Overlay Rose Gold	235.00
DVO-30-3FS	Frame Overlay Satin Stainless Steel	165.00
DVO-30-3FB	Frame Overlay Bronze	195.00
DVO-30-3MRB	Mission Overlay Black (w/ offset frame)	550.00
DVO-30-3MVI	Mission Overlay Vintage Iron (w/ offset frame)	550.00
DVO-30-3MSB	Mission Overlay Bronze (w/ offset frame)	550.00
DVO-30-3NB**	Nest Overlay Black (w/ offset frame)	425.00
DVO-30-3NS**	Nest Overlay Satin Stainless Steel (w/ offset frame)	595.00
Vent Kit		
4DVT33FK	Metal Fab Direct Vent Masonry Relining Kit (3x3)	395.30
** Non Stock Items Available for Order *** Custom Orders require order form to be submitted		



Standard Features:

- Large Viewing Area
- Choice of NG or LP
- Specially crafted Real Fyre log sets
- High performance 125 CFM blower
- Electronic Ignition system with battery backup (iSeries)
- Accent lights highlights logs (iSeries)
- Choice of brick pattern for the look of masonry or black porcelain to reflect the flames
- Surrounds in 3-sided or 4-sided configurations
- Full function remote control to command flame and heat adjustments, thermostatic or timer operations as well as control the blower and light dimmer
- On/Off Remote with temperature display and thermostatic control function



Burnt American Oak

Burnt Split American Oak

Charred Mountain Birch

Charred Ancient Oak

Charred Rustic Oak



3-Sided Surround (Medium)



Herringbone



Traditional



Porcelain



4-Sided Surround (Medium)



Frame Overlay



Mission Overlay



Nest Overlay

In-Stock Items Available within 24 hours or can be picked up from our warehouse!

Non-Stock items normally available within 7-10 Business Days

Additional Items Available ~ Check Manufacturer Pricelists

Item #	Description	MSRP
Choose Firebox		
DVI-36i-11-33N	36" iSeries (IPI) Direct Vent Natural Gas	2880.00
DVI-36i-11-33P**	36" iSeries (IPI) Direct Vent Propane	2880.00
DVI-36m-01-32N	36" mSeries (Millivolt) Direct Vent Natural Gas	2400.00
DVI-36m-01-32P**	36" mSeries (Millivolt) Direct Vent Propane	2400.00
Choose Log Set (1 required)		
DVL-36-2A**	Burnt American Oak	425.00
DVL-36-2S	Burnt Split American Oak	450.00
DVL-36-2CO	Charred Ancient Oak	450.00
DVL-36-2CR**	Charred Rustic Oak	450.00
DVL-36-2MB	Charred Mountain Birch	475.00
Choose Liner (1 required)		
DVP-36-1H	Herringbone Brick Firebox Liner	200.00
DVP-36-1B	Boston Buff Traditional Brick Firebox Liner	200.00
DVP-36-1P	Black Porcelain Firebox Liner	225.00
Choose Surround (1 required) ~ includes hinged panel and mesh barrier screen		
DVS-36-3A	Small 3-Sided Surround	250.00
DVS-36-3B	Medium 3-Sided Surround	275.00
DVS-36-3C	Large 3-Sided Surround	300.00
DVS-36-4A**	Small 4-Sided Surround	275.00
DVS-36-4B**	Medium 4-Sided Surround	300.00
DVS-36-3CUS***	Custom 3-Sided Surround	775.00
DVS-36-4CUS***	Custom 4-Sided Surround	800.00
Choose Decorative Overlay (optional)		
DVO-36-3FG**	Frame Overlay Rose Gold	275.00
DVO-36-3FS	Frame Overlay Satin Stainless Steel	190.00
DVO-36-3FB	Frame Overlay Bronze	225.00
DVO-36-3MRB	Mission Overlay Black (w/ offset frame)	595.00
DVO-36-3MVI	Mission Overlay Vintage Iron (w/ offset frame)	595.00
DVO-36-3MSB	Mission Overlay Bronze (w/ offset frame)	595.00
DVO-36-3NB**	Nest Overlay Black (w/ offset frame)	460.00
DVO-36-3NS**	Nest Overlay Satin Stainless Steel (w/ offset frame)	695.00
Vent Kit		
4DVT33FK	Metal Fab Direct Vent Masonry Relining Kit (3x3)	395.30
** Non Stock Items Available for Order *** Custom Orders require order form to be submitted		

www.FireplaceandChimneyAuthority.com



Standard Features:

- Large Viewing Area
- Choice of NG or LP
- Specially crafted Real Fyre log sets
- High performance 125 CFM blower
- Electronic Ignition system with battery backup (iSeries)
- Accent lights highlights logs (iSeries)
- Choice of brick pattern for the look of masonry or black porcelain to reflect the flames
- Surrounds in 3-sided or 4-sided configurations, standard or custom
- Full function remote control to command flame and heat adjustments, thermostatic or timer operations as well as control the blower and light dimmer
- On/Off Remote with temperature display and thermostatic control function



Burnt American Oak



Burnt Split American Oak



Charred Mountain Birch



Charred Ancient Oak



Charred Rustic Oak



3-Sided Surround (Medium)



Herringbone



Traditional



Porcelain



4-Sided Surround (Medium)



Frame Overlay



Mission Overlay



Nest Overlay

In-Stock Items Available within 24 hours or can be picked up from our warehouse!

Non-Stock items normally available within 7-10 Business Days

Additional Items Available ~ Check Manufacturer Pricelists



Real Fyre™ DVI Gas Insert Custom Surround

Order Form ~ **Once Submitted cannot be Canceled**

Please check the appropriate boxes and fill in **ALL** the dimensions required.
Allow a Minimum of an 1/8" in Height and Width, for fireplace opening irregularities.

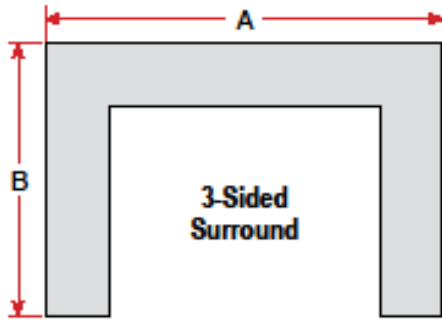

3-SIDED SURROUND

UNIT: DVI-25 DVI-30 DVI-36 QTY: _____

DIMENSIONS A: _____ B: _____

NOTES: _____

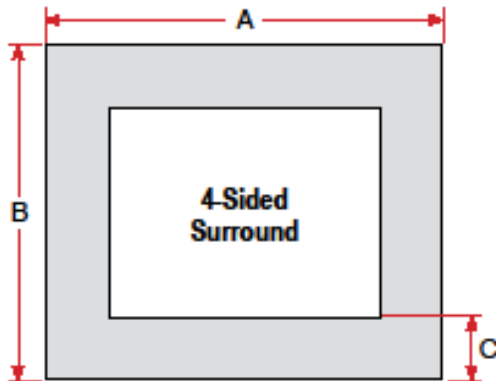

4-SIDED SURROUND

UNIT: DVI-25 DVI-30 DVI-36 QTY: _____

DIMENSIONS A: _____ B: _____ C: _____
(Min. 2")

NOTES: _____

DIMENSIONAL LIMITATIONS:

1. Minimum "A" or "B" dimensions are limited to Small Standard Surround (DVS-**-3A & DVS-**-4A).
2. Maximum "A" or "B" dimension is 60".
3. If "A" dimension exceeds 48", then maximum "B" dimension is 48".
4. If "B" dimension exceeds 48", then maximum "A" dimension is 48".
5. Largest custom surround possible is 48" x 60" or 60" x 48".

WARNING

DIMENSIONS ENTERED HERE SHALL BE DIMENSIONS OF THE DESIRED CUSTOM SURROUND. DO NOT ENTER DIMENSIONS OF THE FIREPLACE OPENING.

Special Comments:

Custom orders require 4-6 weeks for delivery

ORDER TRACKING INFORMATION

Dealer Name: _____ P.O. Number: _____
 Contract's Name: _____ Contact's Phone: _____
 Dealer Email: _____ Date: _____

E-mail or fax this completed form to:
 Sales, sales@fandcdistributors.com or (830) 241-0527

All Custom Surround orders must include a valid P.O. number and will be made to the specifications on this sheet.
 F&C Distributors and Robert H. Peterson assumes no liability for any incorrect information provided on this sheet.

Stocked items listed, additional items available. See the American Fyre Design Price List Included with this Catalog for additional options. Please call with questions.

Item #	Description	MSRP
OCBW-34	34" Beachwood Campfyre Log Set	300.00
PRO-27	27" Prairie Oak Log Set	422.00
DS-27	27" Desert Sage Log Set	447.00
BCO-27	27" Back Country Oak Log Set	447.00
BDS-2	Desert Sage Branches (2-log accent set)	86.00



Desert Sage Branches



Desert Sage

Regrettably, coupons cannot be used on outdoor log sets



Back Country Oak



Beachwood



Prairie Oak



FEATURES:

- GFRC Construction
- Lava Rock Must be Purchased Separately
- Stocked in Back Country Oak, Desert Sage and Beachwood. (*Prairie Oak not stocked)
- Great Accent to Any Outdoor Gas Fire Pit



Professional Services

Table of Contents

Attic Fan Guard	94
Bird Screens	94
Brick Replacement	98
Chimney Rebuild	99
Chimney Replacement	99
Clay Tile Removal	95
Clay Tile Replacement	96
Cleanings and Inspections	93
Crown Coat	97
Crown Replacement	98
Firebox Rebuilding	96
Gas Line Installation	100
Gas Log Conversion	100
Gas Log Refurbishment	100
Gas Log Services - Other	100
Gas Logs	100
Hanging Spark Screens	95
Paint and Peel	97
Roto Cleanings	94
Tuckpointing	98
Water Repellant	97



Service Type	Regular Price	Discount Price
(Fireplace/Furnace) Chimney Cleaning	\$199.50	\$159.50
Dryer Vent Exhaust (via roof)	\$179.50	\$159.50
Dryer Vent Exhaust (via side)	\$159.50	\$139.50
Direct Vent Fireplace or Direct Vent Stove	\$175.00	NO DISCOUNT
Fireplace w/ Wood Insert*	\$179.00	NO DISCOUNT
Fireplace w/ Gas Insert	\$175.00	NO DISCOUNT
Wood Stove	\$179.00	NO DISCOUNT
Grill Cleaning	\$199.99	NO DISCOUNT
Emergency Cleaning	\$199.00	NO DISCOUNT
Service Call (initial visit)	\$175.00	CHICAGO \$225
Inspection – Level 1	\$85.00	NO DISCOUNT
Inspection – Level 2** (required for all home sale transactions)	\$159.00	NO DISCOUNT
Visual Inspection (included w/ above cleanings only)		
Dead Animal Removal	Quote on site (\$95.00 minimum)	NO DISCOUNT
Bird Removal	\$20.00 per bird	NO DISCOUNT
Ash Pit Cleaning	\$20.00 per bag (5 bag minimum using 13 gallon bags)	NO DISCOUNT
Chim-Scan	\$159.99	NO DISCOUNT
Chim-Scan w/ Cleaning	\$249.99	\$249.99
Additional Service Call***	\$65.00 plus parts	NO DISCOUNT
Air Duct Cleaning (1 furnace)	\$225.00	\$175.00
Air Duct Cleaning (each additional furnace)	\$175.00	NO DISCOUNT
Dryer Vent Cleaning via side (w/ air duct cleaning) and Chimney Cleaning	\$85.00	\$65.00

* Price includes insert removal and cleaning of smoke shelf and smoke chamber

** Includes visual inspection and Chim-Scan

*** Any additional service call made as a result of a previously purchased service



Roto Cleaning

Requires Standard Cleaning in addition to cost below

Type	Price
Ranch	325.00
Two-Story	375.00
Three-Story	475.00
Four-Story+	Call for Quote

Bird Screens

Includes Sixty (60) Day Blow-off Warranty

Size	Price
Small Dryer Vent Hose	64.99
Large Dryer Vent Hose	84.99
Iowa Barn Screen (over chimney cap)	159.99
Dryer Vent Cover	59.99

Stainless Steel Attic Fan Guard

Includes Limited Lifetime Mfr Warranty and Sixty (60) Day Blow-off Warranty

Size	Part#	Price
16" x 16"	RVG1616	209.99
25" x 25"	RVG2525	249.99
30" x 30"	RVG3030	319.99

In-Stock Items Available within 24 hours or can be picked up from our warehouse!
 Non-Stock items normally available within 7-10 Business Days
 Additional Items Available ~ Check Manufacturer Pricelists



Hanging Spark Screens

Size	Part#	Price
48" x 18"	61076	149.99
48" x 20"	61078	149.99
48" x 22"	61080	149.99
48" x 24"	61082	149.99
48" x 26"	61084	149.99
48" x 28"	61086	149.99
48" x 30"	61088	149.99

Breakout and Removal of Existing Clay Tiles

Number of Tiles	Price
1-5	475.00
6	575.00
7	625.00
8	675.00
9	700.00
10	780.00
11	850.00
12	920.00
13	990.00
14	1050.00
15	1150.00

In-Stock Items Available within 24 hours or can be picked up from our warehouse!
 Non-Stock items normally available within 7-10 Business Days
 Additional Items Available ~ Check Manufacturer Pricelists



Firebox and Chimney Repairs

Clay Tiles

Tiles come in two (2) foot lengths

We will replace a maximum of three (3) tiles in any one flue

Tile Sizes 8" x 8", 8" x 13" and 13" x 13"	Price
First Tile	250.00
Second Tile	300.00
Third Tile	350.00
Tile Sizes 13" x 18" and 18" x 18"	Price
First Tile	325.00
Second Tile	350.00
Third Tile	375.00

Firebox Rebuilding - Back Wall

Number of Bricks	Price
1-30	1175.00
31-40	1350.00
41-50	1500.00

Firebox Rebuilding - Side Wall

If part of a back wall rebuild

Number of Bricks	Price
1-15	400.00
16-30	524.00
31-45	854.00



Crown Coat

*Complete coverage at top of chimney crown - 1/8" min. thickness
\$20.00 per brick on top row of chimney*

<i>Example</i>	
Number of Bricks	Price
8	160.00
12	240.00
16	320.00

Masonry Water Repellant

10-year Manufacturer's Warranty

Number of Bricks	Price Per Brick
101-200	2.00
201-400	1.75
401-600	1.50
601-800	1.25
801+	1.00

Paint and Peel Brick Reconditioning

	Price
Hearth Only	250.00
Hearth and Fireplace Face	15.00 per Square Foot
Firebox Only	250.00



Crown Replacement

*A new crown includes resetting 1-2 rows of brick below the crown.
The new crown will overhang the brick 2-2½ inches.*

<i>Build New Crown</i>	
Forms	Price
Small / Small	850.00
Small / Medium	950.00
Medium / Medium	1000.00
Small / Large	1000.00
Medium / Large	1150.00
Large / Large	1300.00
Precast Crown	500.00
Call Office for Oversize Crown Pricing	
*** Scaffold Pricing MUST Be Added to Above Pricing ***	

Brick Replacement

Number of Bricks	Price
1-5	350.00
6-10	650.00
Additional bricks over 10	15.00

Tuckpointing

Square Footage	Price
Up to 20 sq. ft.	200.00
21+ sq. ft.	20.00 / sq. ft.
*** Scaffold Pricing MUST Be Added to Above Pricing ***	



Chimney Rebuild

<i>Minimum Charge includes up to 50 Bricks</i>	
Number of Bricks	Price
1-50	650.00
Per Brick Over 50	9.00
Each Corbelled Course	50.00
Each Soldiered Course	150.00
Antenna Remove/Install	60.00
Licensed Masonry Disposal	2% of brick total
*** Scaffold Pricing MUST Be Added to Above Pricing ***	

Scaffold Pricing

Sections	Price
3	150.00
4	200.00
5	250.00
6	400.00
7	800.00

Roof Scaffold Pricing

Sections	Price
1	125.00
2	150.00
3	200.00



Gas Log Refurbish & Conversion

Gas Log to Wood Burning Conversion

*Remove existing gas log set, sweep flue, firebox, and smoke chamber.
Install gas log lighter and perform visual inspection.*

\$299.99 + Parts

Gas Log Refurbishment

Includes:

- Remove all sand and glowing embers
- Remount gas logs to appropriate specifications
- Inspect burner pan and grate
- Brush, check and reset customers logs
- Brush firebox walls, clean the flue and the smoke chamber
- Check gas valve

Log Sizes	Price
30" or Less	179.99
36" to 50"	299.99

Gas Line Installation

	Price
First 10 Feet or less	350.00
Each additional foot	15.00

Other Gas Log Services

	Price
Install Gas Log Set w/ Inspection*	175.00
Install Customer's Log Set	249.00
Install Gas Log Set & Clean Fireplace*	249.99

** Log set must be purchased from Fireplace & Chimney Authority*



Terms and Conditions

Prices:

- All prices are subject to change without notice and all items will be invoiced at prices in effect at time of sale.

Standard Terms of Sale:

- All sales are final. Unless otherwise specified above, any products or services are non-refundable and non-exchangeable, nor will store credit be issued. Customer may cancel any transactions or service without penalty or obligation within three (3) business days from the date of contract. Any balances are due at the time of completion. If customer postpones work after the start date, but before scheduled completion for any reason, the balance for all product and labor will become due. If the project is delayed for any reason, the balance for any labor or product completed to that point will become immediately due. A late payment charge of 1% per month or the maximum allowed by law, if less, will be applied to the balance owed under the invoice after the due-date. Any credit card information given for deposits may be stored on file, and may be used to satisfy balance upon completion of the project. All product remains property of the contractor until balance of project is paid in full. All material is guaranteed to be as specified in the proposal. Any unforeseen work or work not detailed in the above estimate will be billed additionally. Any alteration or deviation from the above specifications involving extra costs will be executed only upon written order, and will become an extra charge over the estimate. Contractors shall not be held responsible for any complication due to lack of maintenance by the customer. This includes, but is not limited to, regular cleaning of fireplaces and barbeque grills as specified by installation manual or user manual. All agreements are contingent upon strikes, accidents, inclement weather, or delays beyond our control. Owner to carry fire, tornado, and other necessary insurance. Contractors are fully covered by Workman's Compensation Insurance. Permits, bonds, or licenses are not included, and are the responsibility of the customer. Standard 2 (two) year warranty on masonry repairs unless liner is deemed unsatisfactory. Contractor warranties the labor on any product installed by them for 1 (one) year. Contractor will not be liable for any service, maintenance, or repairs made by the customer or a third party within or outside the warranty period. All manufacturers' warranty terms will be honored.
- All sales will be **Prepaid** and/or **50% deposit** with the balance due upon completion.
- **Past due accounts will be subject to a 1 1/2% per month service charge on all past due amounts. (18% Annual)**

Pick-ups:

- Pick-ups for cash and carry items/orders are welcome. However, please call at least **two hours prior** to arrival to insure your order will be ready for you when you arrive.

Merchandise Returns:

- No returns will be accepted unless they are in original packaging, are able to be sold as "new" and are subject to a 20% restocking charge.
- Fireplace & Chimney reserves the right to **refuse any return for any reason.**
- **Special orders & Non Stock Items can not be returned.**



*The Midwest's
Largest and most
respected
Fireplace and
Chimney
Company!*

120 E. Lake St.
Elmhurst, IL 60126
630-279-8500

1702 Ogden Ave.
Lisle, IL 60532
630-969-8800