

Modore 185

Direct Vent Gas Fireplaces

Product Information



Modore 185 Video



DANGER

**HOT GLASS WILL CAUSE BURNS.
DO NOT TOUCH GLASS UNTIL COOLED.
NEVER ALLOW CHILDREN TO TOUCH GLASS.**



Une surface vitrée chaude peut causer des brûlures. Laisser refroidir la surface vitrée avant d'y toucher. Ne permettez jamais à un enfant de toucher la surface vitrée.

A barrier designed to reduce the risk of burns from the hot viewing glass is provided with this appliance and shall be installed for the protection of children and other at-risk individuals.

Une barrière conçu pour réduire le risque de brûlure par le verre de visualisation chaude est fournie avec cet appareil et doit être installé pour la protection des enfants et autres personnes à risque.

 **WARNING:**
FIRE OR EXPLOSION HAZARD
Failure to follow safety warnings exactly could result in serious injury, death, or property damage.

- Do not store or use gasoline or other flammable vapors and liquids in the vicinity of this or any other appliance.
- **WHAT TO DO IF YOU SMELL GAS**
 - Do not try to light any appliance.
 - Do not touch any electrical switch; do not use any phone in your building.
 - Leave the building immediately.
 - Immediately call your gas supplier from a neighbor's phone. Follow the gas supplier's instructions.
 - If you cannot reach your gas supplier, call the fire department.
- Installation and service must be performed by a qualified installer, service agency or the gas supplier.

 **AVERTISSEMENT:**
INCENDIE OU D'EXPLOSION
Le non-respect des avertissements de sécurité à la lettre pourrait entraîner de graves blessures, la mort ou des dommages matériels.

- Ne pas entreposer ni utiliser d'essence ni d'autres vapeurs ou liquides inflammables dans le voisinage de cet appareil ou de tout autre appareil.
- **QUE FAIRE SI VOUS SENTEZ UNE ODEUR DE GAZ**
 - Ne pas tenter d'allumer d'appareil.
 - Ne touchez à aucun interrupteur. Ne pas vous servir des téléphones se trouvant dans le bâtiment ou vous trouvez.
 - Quitter immédiatement le bâtiment.
 - Appelez immédiatement votre fournisseur de gaz depuis un voisin. Suivez les instructions du fournisseur.
 - Si vous ne pouvez rejoindre le fournisseur de gaz appelez le service des incendies.
- Installation et l'entretien doivent être effectués par un installateur qualifié, une agence de service ou le fournisseur de gaz.

INSTALLER: Leave this manual with the appliance.
CONSUMER: Retain this manual for future reference.

INSTALLATEUR: Laissez cette notice avec l'appareil.
CONSOMMATEUR: Conservez cette notice pour consultation ultérieure.

TABLE OF CONTENTS

Important Safety Information.....	3
Key Installation Points	6
User Information.....	7
Specifications and Dimensions	8
<i>Modore 185</i>	9
<i>Parts of the Fireplace</i>	10
Clearances.....	12
<i>Locating the Fireplace</i>	12
<i>Placing the Fireplace</i>	12
<i>Clearances to Combustibles</i>	13
<i>Clearances to Non-Combustibles</i>	13
<i>Mantel Clearances</i>	14
<i>Convection Clearances</i>	15
Gas and Electric.....	16
Venting.....	17
<i>Configuration</i>	17
<i>Venting Charts</i>	20
<i>Venting Clearances</i>	21
Enclosing the Fireplace	23
<i>Non-Combustible Materials List</i>	23
<i>Building the Enclosure</i>	24
<i>Reduced Clearance To Existing Walls</i>	24
<i>Convection Air Opening</i>	28
<i>Cold Climate Installation</i>	30
<i>Wall Access Door (Locating & Mounting)</i>	30
Installing the Fire Media	33
Screen Installation.....	35
Operating the Fireplace	39
Maintenance	45
<i>Glass</i>	45
<i>Burner</i>	47
<i>Pilot</i>	47
<i>Thermocouple</i>	48
<i>Venting</i>	48
Replacement Parts	48
Warranty	49
Massachusetts Certification.....	Appendix One
Troubleshooting Flowchart	Appendix Two
Installing the Optional Wall Switch.....	Appendix Three
Connecting To A Smart Home System.....	Appendix Four
Index	---

IMPORTANT SAFETY INFORMATION

CAUTION - HOT! HOT! HOT!

This appliance is a HEATING appliance and it does become very hot in operation. UNDER ANY CIRCUMSTANCES, DO NOT PLACE any object, furniture, draperies or other item LESS THAN 36"/90 cm IN FRONT OF THE GLASS OF THE FIREPLACE.

CHILDREN AND PETS

Radiant heat can heat surfaces such as the surround and trims of the fireplace to temperatures that, although approved safe, can be quite uncomfortable to touch - particularly for children and pets. Children and pets should always be supervised when in the room where the appliance is located. Remote control handset should be kept out of reach of children. In the presence of children, we STRONGLY RECOMMEND that you install in front of the fireplace: a fire screen or, to protect young toddlers, a "hearth gate".

HOT SURFACES

Be aware that, although safe, some combustible materials and finishes, even though installed at listed clearances may, over time, discolor, warp or show cracks.

Convective heat will exit the unit and travel up the wall surface if not impeded. Protruding mantels and projections can help direct the heat away from the wall. AVOID placing heat sensitive items such as televisions, paintings, decorations, etc. above fireplaces or near the edge of protrusions unless appropriate.

Do not place furniture or other objects within 36" of the fireplace glass.

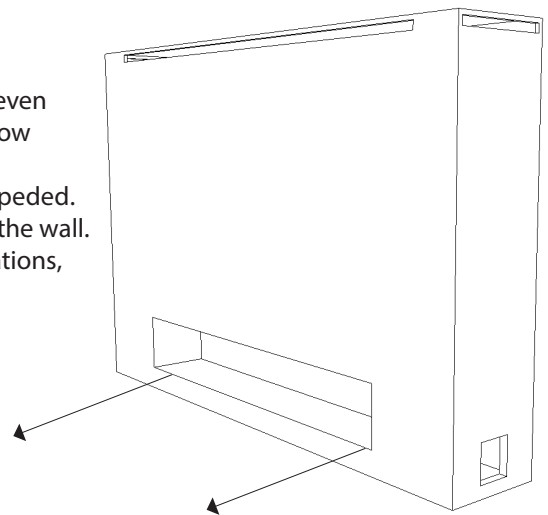

SAVE THESE INSTRUCTIONS

Make yourself fully aware of all the following instructions and the many features of the Element4 direct vent gas fireplace appliance.

INSTALLER: Leave this manual with the appliance.

OWNER: Keep this manual for future reference.

IMPORTANT SAFETY INFORMATION

WARNING

Children and adults should be alerted to the hazards of high surface temperature and should stay away to avoid burns or clothing ignition.

WARNING

This direct vent system appliance must be installed as an OEM installation in manufactured homes (USA only) or an aftermarket permanently located, or a mobile home, **where not prohibited by local codes** and must be installed in accordance with Manufacturer's instructions and the Manufactured Home Construction and Safety Standard, Title 24 CFR, Part 3280, in the United States, or the Standard for Installation in Mobile Homes, CAN/CSA Z240 MH Series, in Canada.

If the information in these instructions is not followed exactly a fire or explosion may result causing property damage, personal injury or death.

Do not store or use gasoline or other flammable vapors and liquids in the vicinity of this appliance.

WARNING: Glass Handling

The glass must only be removed by a qualified person. Gloves should be worn when removing the glass.

WARNING: Installation and Service

Installation and service must be performed by an authorized qualified installer, service agency or gas supplier.

Any alteration to the product that causes soot or carbon to form and results in damage is not the responsibility of the manufacturer.

ONLY a qualified person may open the door/remove the glass.

Do not modify or substitute any part of this appliance.

WARNING: Electrical Grounding

These direct vent appliances must be electrically grounded in accordance with the local codes or, in the absence of local codes, with National Electric code, ANSI/NFPA 70, or the Canadian Electric Code, CSA C22.1

WARNING: Gas Appliance

This appliance is only for use with the type of gas indicated on the rating plate. These appliances are not convertible for use with other gases unless a certified kit is used and the conversion is performed by an authorized qualified technician.

Applicable standards are ANSI Z21.50/CSA 2.22 (Vented Gas Fireplaces) and CAN/CGA 2.17-M91 (Gas-fired Appliances for Use at High Altitudes.) If your installation is at an elevation greater than 2000' in the US or 4500' in Canada, consult with the local authority having jurisdiction for gas product installations to determine their specific requirements for high altitude installations.

IMPORTANT SAFETY INFORMATION

This gas fireplace and vent assembly **MUST** be vented directly to the outside and **MUST NEVER** be attached to a chimney serving a separate solid fuel burning appliance. Each gas appliance **MUST BE** a separate vent system. Common vent systems are prohibited.

TURN OFF the gas before servicing the appliance. It is recommended that a qualified service technician perform an appliance check-up/service once a year.

Any safety screen or guard removed for servicing **MUST BE REPLACED** before operating this appliance.

This unit **MUST** be used with a vent system as described in this installation manual. **NO OTHER VENT SYSTEM OR COMPONENTS MAY BE USED.**

THIS UNIT IS NOT FOR USE WITH SOLID FUEL, and must only be used with gas supply conditions as indicated on the rating label.

INSPECT the external vent cap on a regular basis to make sure that no debris, plants, trees, or shrubs are interfering with the air flow.

DO NOT USE this appliance if any part has been under water. Immediately call a qualified service technician to inspect the unit and to replace any part of the control system and any gas control that has been under water.

NEVER OBSTRUCT the flow of ventilation air. Keep the front of the appliance **CLEAR** of all obstacles and materials for servicing and proper operation.

DO NOT use this appliance as a temporary source of heat during construction.

This appliance is a vented gas fireplace. It must not be used for any other purposes such as drying clothes, etc.

The glass panels **MUST** be in place and sealed before the unit can be placed into safe operation.

DO NOT OPERATE this appliance with the glass panels removed, cracked or broken. Replacement of the glass panels should be performed by a licensed or qualified service person. **DO NOT** strike or slam the glass panels.

The glass panels **SHALL ONLY** be replaced by units supplied by the manufacturer. **NO SUBSTITUTE** panels shall be used.

DO NOT USE abrasive cleaners on the panels. **DO NOT ATTEMPT** to clean the glass panels when they are hot.

If the pilot flame is extinguished either intentionally or unintentionally, no attempt should be made to re-light the gas until at least 3 minutes have elapsed.

Dimensions will appear as **INCHES**/³/metric throughout this manual. For convenience, the inches are rounded to the nearest 1/16" when converted. If greater accuracy is required, use the metric dimensions.

KEY INSTALLATION POINTS



IMPORTANT INFORMATION



This page references the most important key installation points when installing any Element 4 fireplace. This page **DOES NOT** substitute for reading the entire manual.

RECORDS

- The installer **MUST** record the serial number and venting configuration to use for any technical issues that may arise.

ELECTRICAL

- An approved 120V AC wall receptacle is required. The receiver **MUST** be powered by the AC adapter. (4) AA batteries may be used only for on-demand electrical requirement during power outage.

FIRE MEDIA

- When installing the fire media make sure to **NEVER** mix different types of media or use media purchased from another retailer. **ALWAYS** keep the second thermocouple AND pilot free from media.

CONVECTION AIR

- The convection air outlets **MUST** be installed **BEFORE** the first light. The amount of square inches needed for the opening varies from model to model.

ENCLOSING THE FIREPLACE

- ONLY** a tested and approved non-combustible wallboard that is specified in the manual may be used when enclosing the fireplace.

VENTING

- The venting **MUST** follow the model specific graph shown in the manual. A restrictor may or may not need to be used based on venting run and rise.

CONSTRUCTION DEBRIS

- REMEMBER** that if the fireplace is installed before the site is finished, construction debris **MUST** be cleaned from the enclosure and around the unit prior to finishing and the test fire.

GAS PRESSURES

- Gas pressures **MUST** be read with a manometer and confirmed with what is required in the installation manual.

FINISHING

- A 1/8"/3 mm gap between the flange and the enclosing wallboard **MUST** be maintained to prevent cracking from heat expansion and contraction.

USER INFORMATION

WARMTH AND BEAUTY - HOW IT WORKS

The Element4 fireplaces are direct vent fireplaces and, as such, the intake and exhaust are both handled through the vent pipe. The fireplace also provides convection air to your room. The illustration shows one of the unique features of the Element4 fireplaces - its use of warm, convection air flow.

Other fireplaces have louvered metal boxes around them to keep temperatures under control. The Element4 fireplaces use your enclosing walls, or chase, to guide this warm air. This design, therefore, requires the use of non-combustible wall materials and gives you beauty for your effort.

When the air within the chase is warmed by the fireplace, it rises and exits through the Convection Air Outlet. This chase air is then replaced by room air which enters the chase through the Room Air Inlet and through the Wall Access Door. As the exiting warm air cools, it falls to the floor where it's drawn into the inlets and the cycle repeats.

The fireplace provides the *inlet* for room air as part of its design; you provide the warm air *outlet* as part of your design.

See the **ENCLOSING the FIREPLACE** section of this manual for more information.

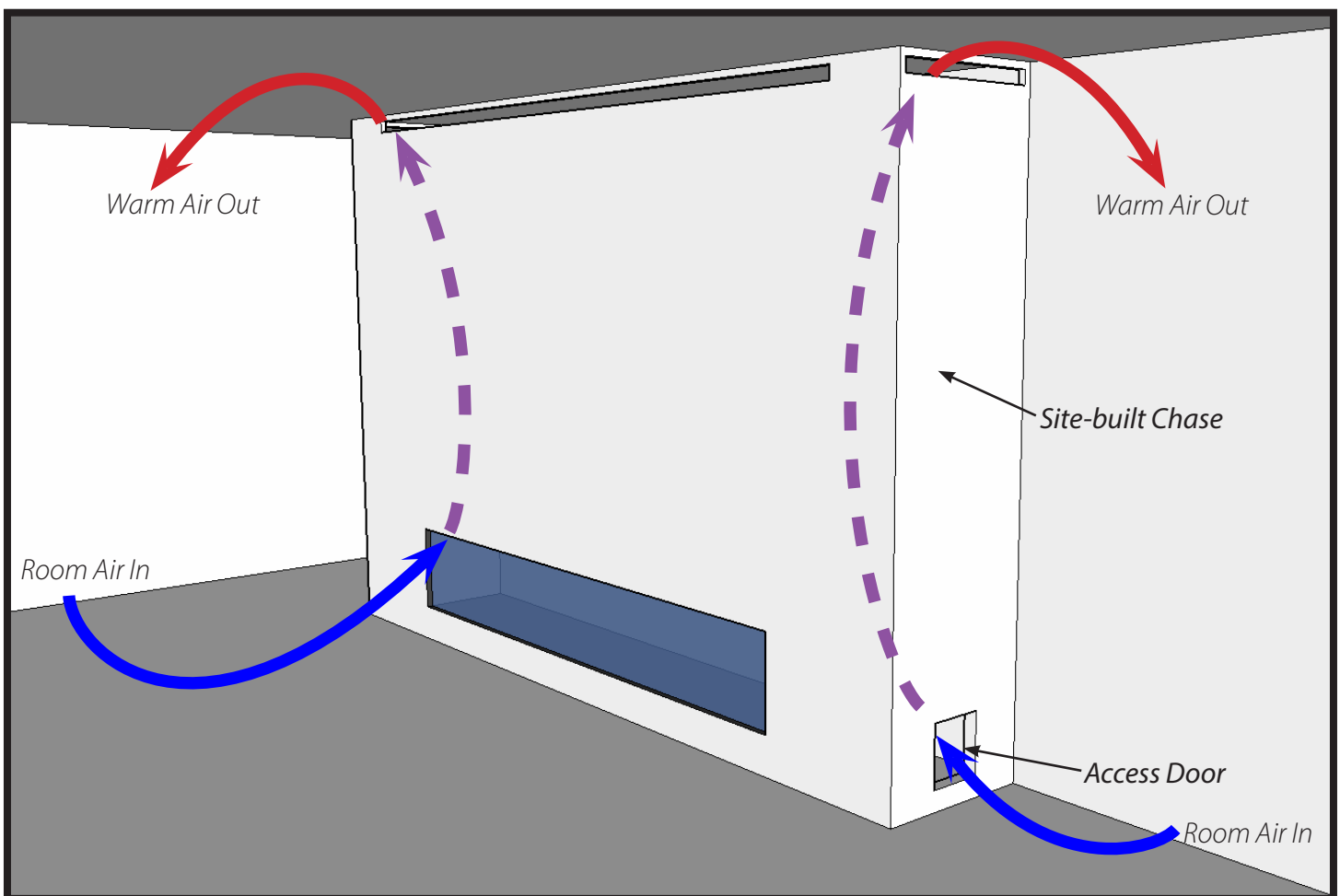

SPECIFICATIONS and DIMENSIONS

APPLIANCE RATINGS

Model		Modore 185	
Gas		Natural Gas	Propane
Input Maximum	Btu/hr	70,000	48,000
Input Minimum	Btu/hr	19,500	13,000
Maximum Supply Pressure	in. w.c.	7	11
	kpa	1.74	2.74
Minimum Supply Pressure	in. w.c.	4	8
	kpa	1	2
Manifold Pressure Maximum	in. w.c.	4.3	11
	kpa	1.06	2.74
Manifold Pressure Minimum	in. w.c.	2.2	5
	kpa	0.55	1.24
Main Burner Injector Marking		650 (x1) 560 (x2)	220 (x3)
Pilot Injector Marking		31.2	27.1
Efficiency		82.8%	

AC ADAPTER SPECIFICATIONS	
Input Voltage	120V AC
Input Power	9 W
Output Voltage	6V DC
Output Current	500 mA
Size	3.1"H x 2"W x 1.7"D
Output Cord Length	6 Feet
Agency Approvals	UL, CSA



AC Adapter

DO NOT REMOVE
DIRECT VENT GAS FIREPLACE - Not for use with solid fuel.

This appliance is only for use with the type of gas indicated on the rating plate and may be installed in an aftermarket, permanently located, manufactured home (USA only) or mobile home where not prohibited by local codes. See owner's manual for details. This appliance is not convertible for use with other gases, unless a certified kit is used.

For use only with Vent, Glass Panels and Ceramic Logs (or stones) certified and approved for use with this appliance.

This appliance must be installed in accordance with local codes, if any; if none, follow ANSI Z223.1/NFPA 54, or CSA B149.1. The appliance must be properly connected to a venting system in accordance with the manufacturer's installation instructions.

The system must be installed by a qualified installing agency.

NE PAS RETIRER
FOYER GAZ À AÉRATION DIRECTE - Ne pas utiliser avec un combustible solide

Cet appareil est destiné uniquement avec le type de gaz indiqué sur la plaque signalétique et peut être installé dans une habitation en dur, à emplacement fixe (USA uniquement) ou dans une résidence mobile si la législation locale l'autorise. Consultez le manuel du propriétaire pour les détails. Cet appareil ne doit pas être modifié pour une utilisation avec d'autres gaz, sauf à l'aide d'un kit certifié.

À utiliser uniquement avec des ventilations, panneaux en verre et pierres (ou pierres) en céramique dont l'utilisation est autorisée avec cet appareil.

Cet appareil doit être installé conformément à la législation locale. À défaut d'une telle législation, suivre ANSI Z223.1/NFPA 54, ou CSA B149.1. L'appareil doit être correctement raccordé à un système de ventilation, conformément aux instructions d'installation du fabricant.

Le système doit être installé par un installateur qualifié.

Manufacturer/ Fabricant: Element4 B.V. Paxtonstraat 23 NL-8013 RP Zwolle The Netherlands / Pays-Bas
Tel / Tél : 0031 38 4209020 Fax:0031 38 4209021

Approved By / Approuvé par: Intertek

Control No. : 4008611
Conforms to std. ANS Z21.50a-2008
Certified to std. CSA 2.22a-2008 - Vented Gas Fireplaces

Product name: (check one) / Nom du produit : (cochez ...)

Serial No. / N° de série: _____

This appliance equipped only for altitudes / Cet appareil est équipé uniquement pour les altitudes : 0-4500 ft / 0-1370 m

Fuel Type / Type de combustible	Natural Gas / Gaz naturel	Propane Gas / Gaz propane
(check one) / (cochez...)	[]	[]

Max. Input / Capacité d'entrée maxi (BTU/HR)
Min. Input / Capacité d'entrée mini (BTU/HR)
Gas Inlet Pressure (in w.c.) / Pression d'entrée du gaz (en w.c.)
Manifold Pressure (in w.c.) / Pression d'admission (en w.c.)
Orifice Size / Taille de l'ouverture

Clearances to combustible / Dégagement jusqu'au combustible :

Back / Arrière :	Sides / Côtés :	
Top / Haut :	Floor / Sol :	
Mantel / Linteau :		

A typical rating label is shown above. It is attached to every Element4 fireplace and contains important certification information. *It must not be removed from the fireplace.*

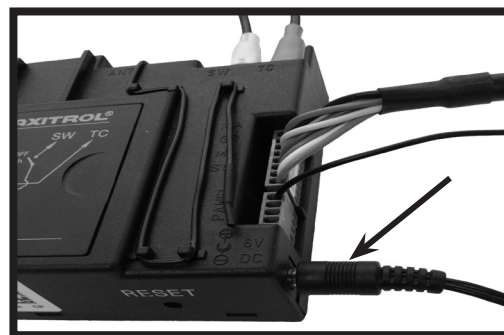

AC Adapter Connection (arrow)

SPECIFICATIONS and DIMENSIONS

MODORE 185

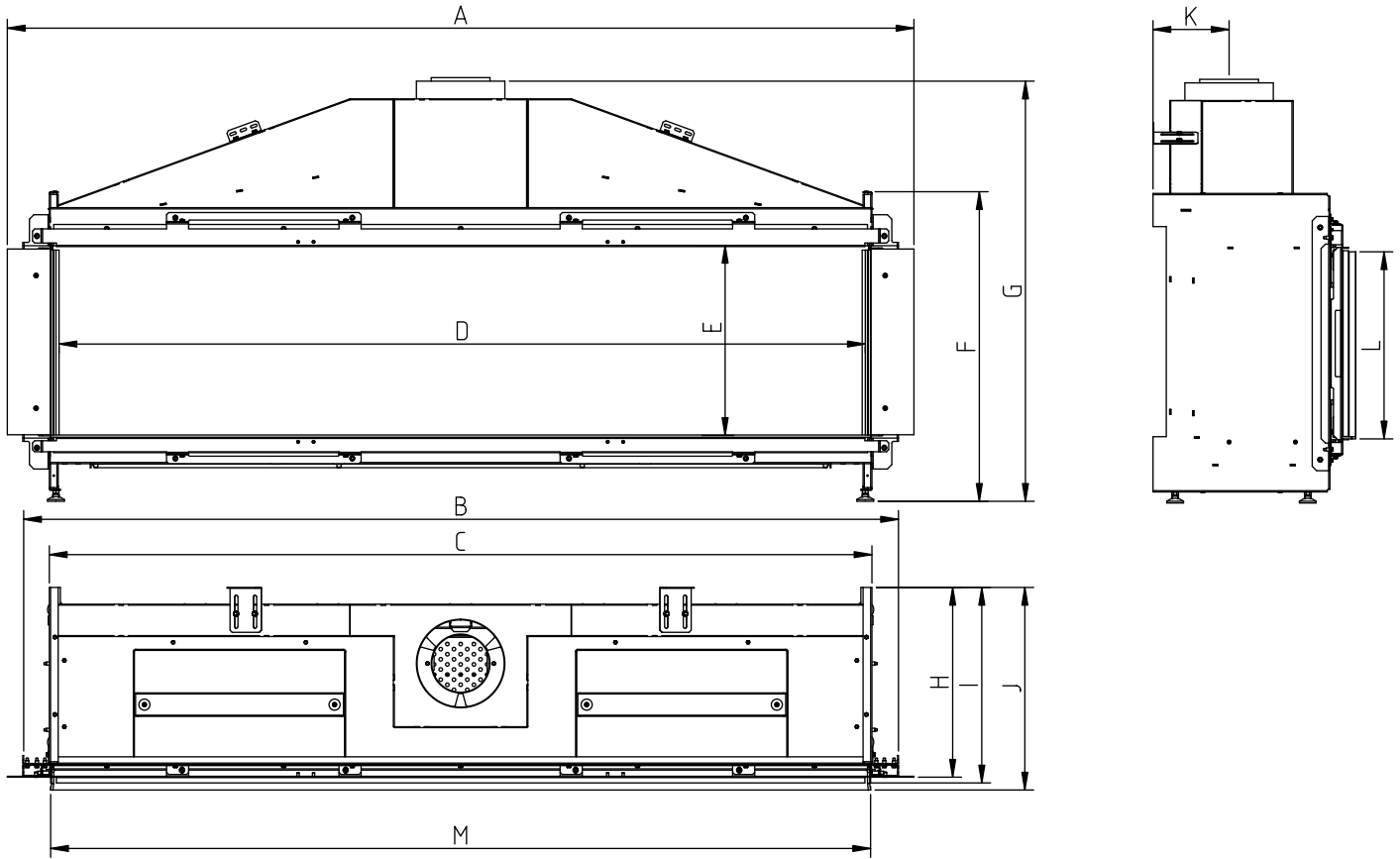

Letter	Inches	Millimeters
A	80 ³ / ₄	2050
B	77 ⁷ / ₈	1978
C	73 ¹ / ₄	1860
D	71 ¹³ / ₁₆	1823
E	16 ¹⁵ / ₁₆	430
F	27 ⁹ / ₁₆	700
G	37 ⁷ / ₁₆	950
H	16 ¹⁵ / ₁₆	429
I	17 ⁷ / ₁₆	442
J	18 ¹ / ₁₆	458
K	6 ¹³ / ₁₆	172
L	16 ¹¹ / ₁₆	423
M	73	1854

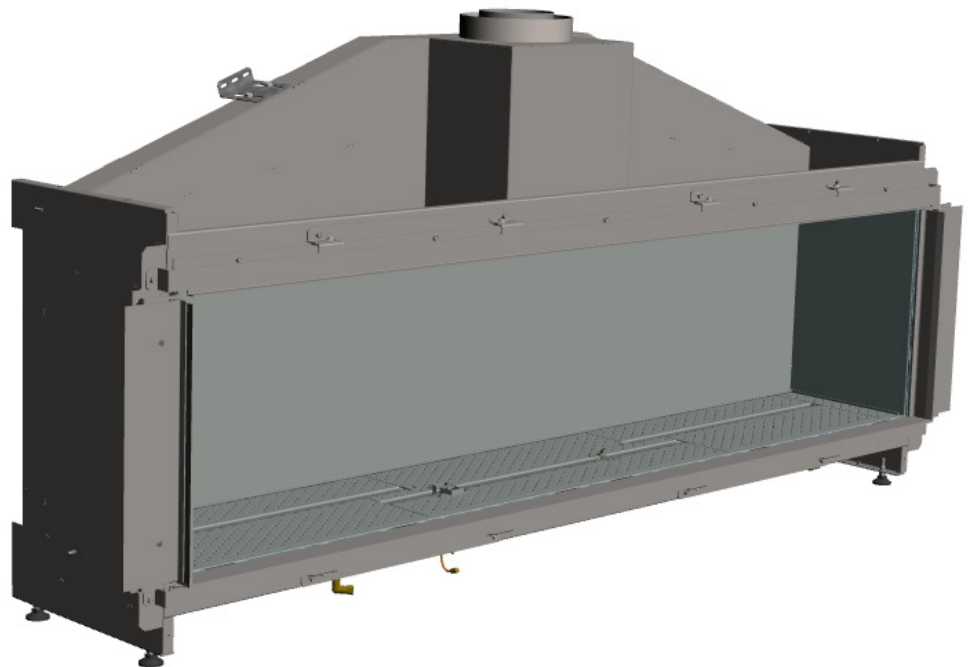

MODORE 185

A DWG file is available for download at www.europeanhome.com for design specific dimensions not listed.

SPECIFICATIONS and DIMENSIONS

PARTS OF THE FIREPLACE

The various parts of the Modore 185 fireplace are shown below. These parts are typical of any Element4 fireplace.

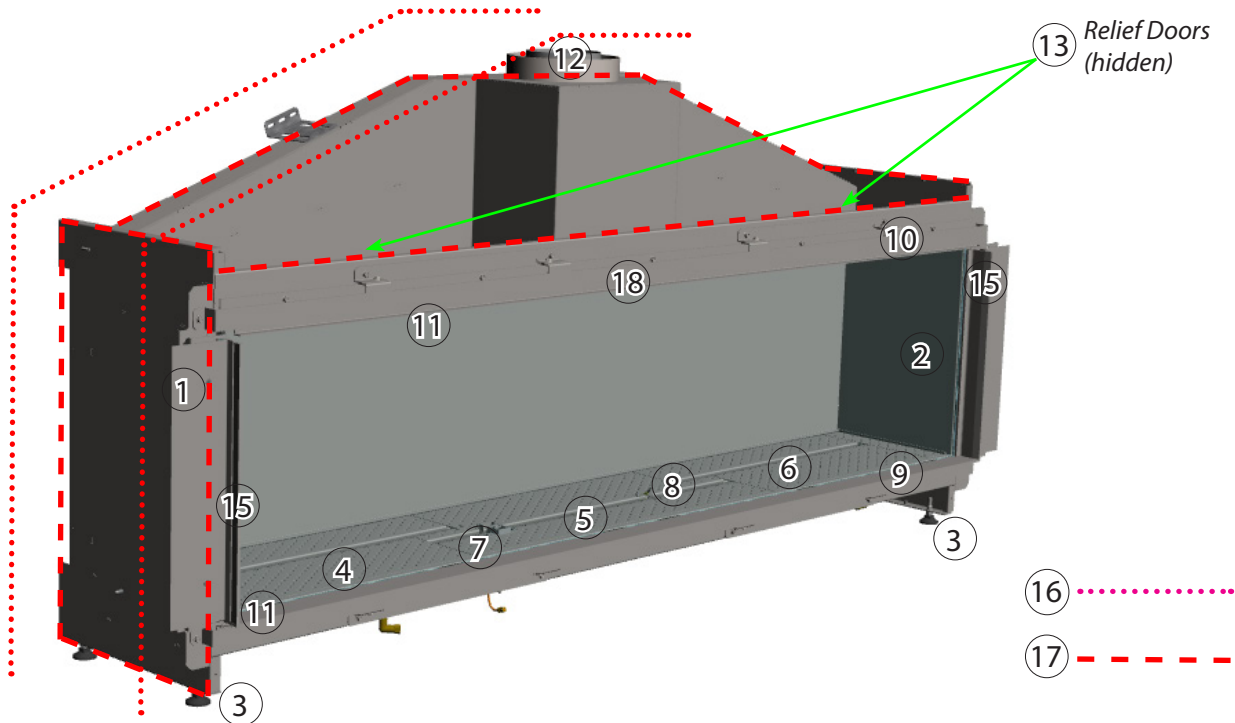

The "No Material Zone" and the "Top of Fireplace" is the same for both sides of the fireplace.

Table of Fireplace Parts	
①	Outer Frame Face- surrounds the glass panel(s) and limits the non-combustible wall board
②	Exterior Glass Panel
③	Support Feet - four adjustable feet allow the fireplace to be levelled
④	Hearth Panel - supports various Fire Media
⑤	Primary Burner - produces the front flame
⑥	Secondary Burner - produces the rear flame; may be controlled separately
⑦	Pilot Thermocouple - the part of the safety system which lights the Main Burner
⑧	2 nd Thermocouple - the part of the safety system which monitors the Main Burner
⑨	Finish Trim - hides the Glass Rope Gasket
⑩	Room Air Inlet (hidden)
⑪	Glass Rope Gasket - holds the Glass Panel in place (2 - hidden)
⑫	Vent Collar - accepts the 5" x 8" venting adapter (included)
⑬	Relief Door - part of the safety system. Do NOT block the operation. Check BEFORE 1st light.
⑭	Pilot Assembly
⑮	Side Trim - (2)
⑯	NO MATERIAL zone
⑰	Top of fireplace
⑱	Flange

SPECIFICATIONS and DIMENSIONS



Fireplace from below

Table of Fireplace Parts	
①	Outer Frame Face- surrounds the glass panel(s) and limits the non-combustible wall board
②	Exterior Glass Panel
③	Support Feet - four adjustable feet allow the fireplace to be levelled
④	Hearth Panel - supports various Fire Media
⑤	Primary Burner - produces the front flame
⑥	Secondary Burner - produces the rear flame; may be controlled separately
⑦	Pilot Thermocouple - the part of the safety system which lights the Main Burner
⑧	2 nd Thermocouple - the part of the safety system which monitors the Main Burner
⑨	Finish Trim - hides the Glass Rope Gasket
⑩	Room Air Inlet (hidden)
⑪	Glass Rope Gasket - holds the Glass Panel in place (2 - hidden)
⑫	Vent Collar - accepts the 5" x 8" venting adapter (included)
⑬	Relief Door - part of the safety system. Do NOT block the operation. Check BEFORE 1st light.
⑭	Pilot Assembly
⑮	Side Trim - (2)
⑯	NO MATERIAL zone
⑰	Top of fireplace
⑱	Flange

CLEARANCES

These are **NOT** zero-clearance fireplaces. All clearances to combustible AND non-combustible materials **MUST** be maintained as described in this manual.

LOCATING THE FIREPLACE

When selecting a location for the fireplace:

- Ensure that all minimum clearances to combustible AND non-combustible materials are met.
- Provide adequate clearances for servicing.
- Consider venting dimensions (rise, run and number of elbows, etc.) when selecting the location for your fireplace.
- Locate the appliance out of traffic and away from furniture and draperies.
- Keep the location free of electrical, plumbing or other heating/air conditioning ducting.

PLACING THE FIREPLACE

The base upon which the appliance rests must be sturdy, level and built to safely support at least 500 pounds/230 kilograms. The base may be the floor or a purpose-built raised platform, e.g. wood, metal. When placed on a platform, an 8"/203 mm x 6"/152 mm opening must be cut through the platform top. The lineset can be routed through this opening. Room air must be allowed to flow through the Wall Access Door then through this opening.



The feet on the appliance are designed to sit on a flat platform, however the appliance must not be installed on any combustible material other than wood. For example, carpet or linoleum bases are not permitted.

Do not place anything between the bottom of the firebox and the bottom of the feet.

ENSURE THAT THE LINESET (WHICH INCLUDES THE GAS VALVE, ELECTRICAL WIRING, AND GAS LINES) DOES NOT IMPEDE THE FULL OPERATION OF THE RELIEF DOORS. IT IS YOUR RESPONSIBILITY TO ENSURE THE SAFETY OF THESE CRITICAL COMPONENTS THROUGHOUT THE INSTALLATION PROCESS.

MINIMUM CLEARANCE TO COMBUSTIBLES

- The appliance is approved with a minimum clearance to combustible materials of 26"/660 mm to the top, 11"/280 mm on all sides and 4"/100 mm to the bottom. Any spacer or framing used closer than this dimension must be non-combustible (e.g. metal).
- The minimum distance from the bottom of the appliance to the room ceiling is 72"/1830 mm.
- When installing the venting, the following clearances to combustible materials **MUST** be maintained:
 - a. 3"/76 mm above any horizontal venting
 - b. 1"/25 mm to venting sides or below any horizontal venting
- Do not block or restrict the Room Air Inlet, located between the standoff frame and glass.

The minimum clearances (air spaces) to combustible materials must be maintained. It is of the greatest importance that the fireplace and vent system be installed only in accordance with these instructions.

Clearance to combustibles summary:

Back: 11"/280 mm
Sides: 11"/280 mm
Top: 26"/660 mm
Floor: 4"/100 mm

The **Floor** dimension (above) is measured from the bottom of the firebox. When the adjustable feet are in their lowest position the required clearance to the floor is maintained.

CLEARANCES TO **COMBUSTIBLE** MATERIAL

<i>Clearances to Combustibles</i>	
<i>Sides (Non-Glass Sides ONLY)</i>	11"
<i>Top</i>	26"
<i>Bottom</i>	4"

CLEARANCES TO **NON-COMBUSTIBLE** MATERIAL

<i>Clearances to Non-Combustibles</i>	
<i>Sides (Non-Glass Sides ONLY)</i>	2"
<i>Top</i>	2"
<i>Bottom</i>	4"

No material of any kind is allowed between the bottom of the support feet and the bottom of the firebox (except for the lineset).

No material of any kind is allowed within 2"/50 mm from the top of the fireplace.

No material of any kind is allowed within 2"/50 mm from the metal sides the fireplace.

Facing material should be installed against the outer frame of the fireplace, with an 1/8"/3 mm vertical or horizontal clearance TO THE FLANGE allow for heat expansion.

Non-combustible materials may be installed to a zero clearance to the outer faces of the appliance outer frame face. However, they must not cover (or prevent the removal of) the glass panels or other fireplace parts.

Below the feet materials may be combustible (except for the use of linoleum or carpeting of any type).

These clearances are the same for ALL Element 4 Fireplaces, regardless of model.



Please refer to the "Reduced Clearance to Existing Combustible Wall" section for use of combustibles inside of the above clearances.

CLEARANCES

MANTELS

The graph below shows a range of allowable depths and heights for a *combustible* mantel installation.

As shown, the minimum allowable mantel height above the fireplace opening is 2"/50 mm with a 1"/25 mm deep mantel.

The maximum mantel depth is 12"/300 mm at a minimum height above the fireplace opening of 13"/330 mm.

All of the mantel height/depth combinations fall in between these extremes in accordance with the chart below.

Mantels made of *non-combustible* material are allowed inside these dimensions but they will be subjected to elevated temperatures and may become too hot to touch.

A typical completed installation with mantel is shown in the diagram below, on the right.

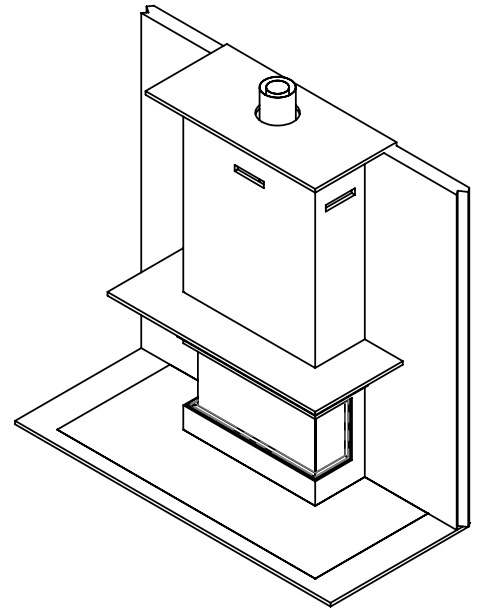
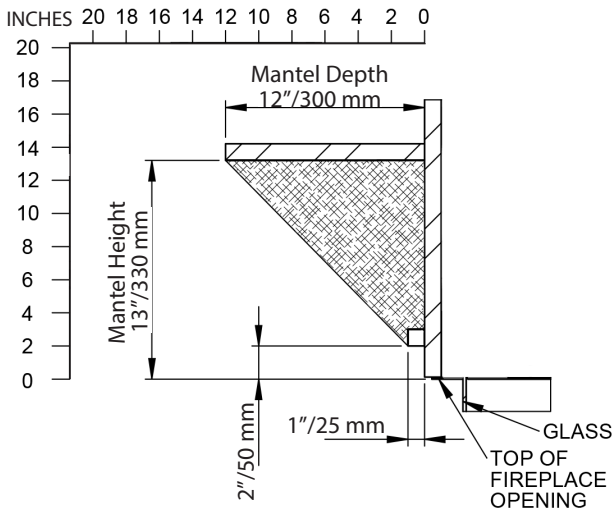

CLEARANCES

TYPICAL CLEARANCE DIAGRAMS

The total area of the convection air outlet(s) depends on the fireplace model. The location of the outlet(s) must allow for the free movement of air and must not allow excessive convection air to build up within the chase.

The top of the outlet(s) must be *at least* 1"/25 mm down from the *room* ceiling.

The top of the outlet(s) must be *no more* than 1"/25 mm down from the *chase* ceiling.

The minimum distance from the bottom of the appliance to the room ceiling is 72"/1830 mm.

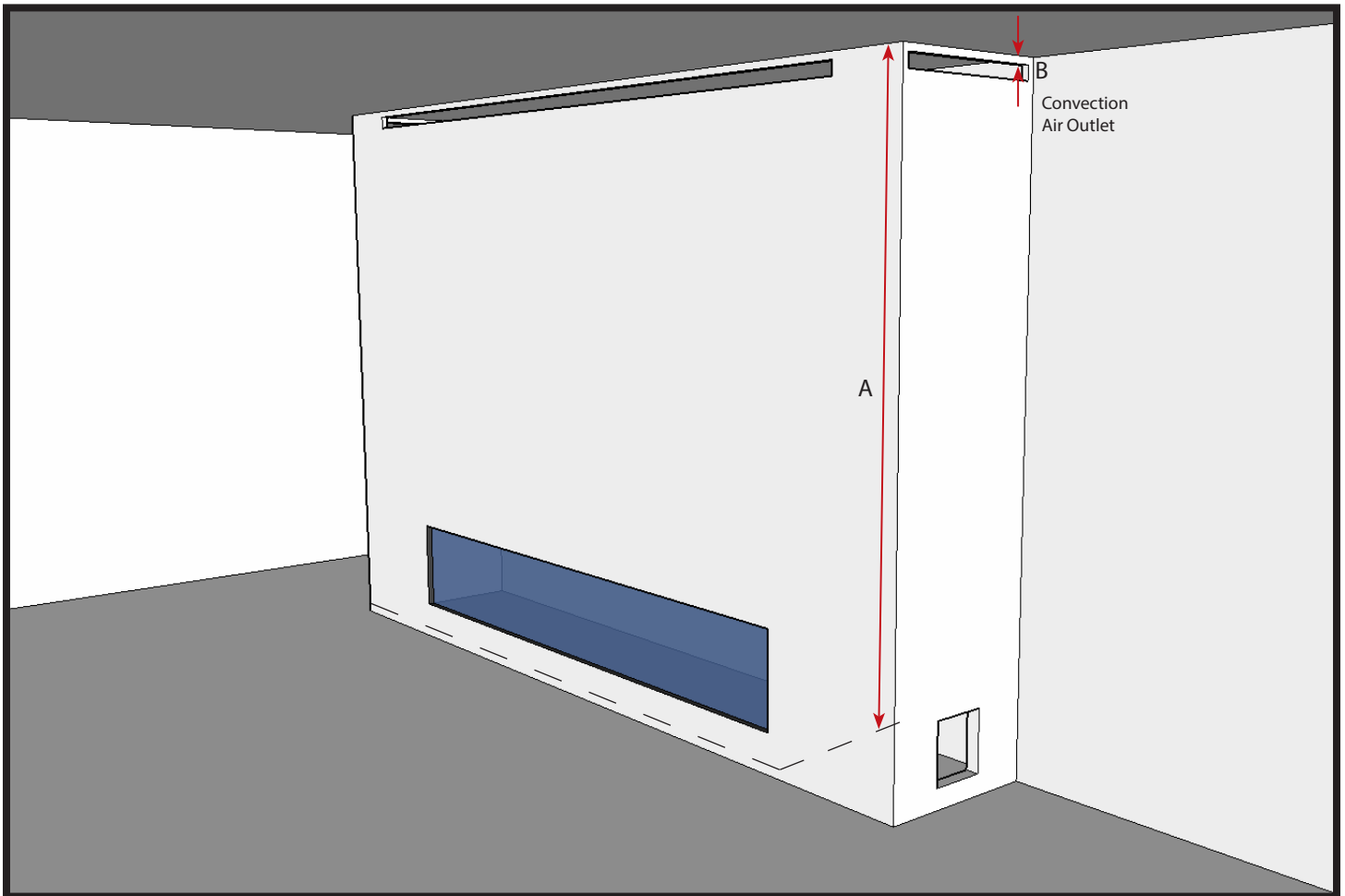

Minimum Distances		
A	Room ceiling to appliance bottom	72" 1830 mm
B	Room ceiling to top of Convection Air Outlet	1" 25 mm

Convection Air Outlet Area by Model		
Model	Square Inches	Square Centimeters
Modore 185	126	813

GAS and ELECTRIC

INSTALLING THE GAS LINE

Correctly size and route the gas supply line from the supply regulator to the area where the appliance is to be installed as per requirements outlined in the latest edition of the National Fuel Gas Code, NFPA 54 (USA) or CAN/CSA-B149.1 (Canada).

Never use galvanized or plastic pipe unless specified for use with gas. Refer to the table below for proper sizing of the supply gas line. Gas lines must be routed, constructed and made of materials that are in strict accordance with local codes and regulations. A qualified plumber or gas fitter should be hired to correctly size and route the gas supply line to the appliance.

Installing a gas supply line from the fuel supply to the appliance involves numerous considerations of materials, protection, sizing, locations, controls, pressure, sediment trap, and other criteria. The sizing and/or installing of gas piping should only be performed by a qualified plumber or gasfitter.

The gas control inlet accepts a $\frac{3}{8}$ " NPT fitting.

This fireplace is shipped from the factory for use with natural gas. See appendix for LP (propane) conversion instructions.

Schedule 40 Black Iron Pipe		
	Natural Gas	Propane Gas
Length (feet)	Inside Diameter (Inches)	
0 - 10	$\frac{1}{2}$	$\frac{3}{8}$
10 - 40	$\frac{1}{2}$	$\frac{1}{2}$
40 - 100	$\frac{1}{2}$	$\frac{1}{2}$
100 - 150	$\frac{3}{4}$	$\frac{1}{2}$
150 - 200	$\frac{3}{4}$	$\frac{1}{2}$

ELECTRICAL REQUIREMENTS

The Element 4 fireplaces use a receiver and remote control for their burner operation. The remote control comes with (2) AAA batteries and the receiver is powered by a 120V AC adapter, included. The fireplace should be powered by the AC adapter for improved reliability and customer satisfaction.

The installer must provide an approved 120V AC wall receptacle to be placed within the six foot cord limit of the AC adapter.

The receiver **MUST** be powered by the AC adapter. (4) AA batteries may be used only for on-demand electrical requirement during a power outage. Remove batteries after use to avoid battery corrosion. Battery corrosion will damage the receiver.



WARNING

Electrical work must be performed by a qualified, licensed electrician.

All wiring shall be in compliance with all local, city, and state codes.



CONFIGURING THE VENTING

The fireplaces in this manual are direct vent fireplaces that use a co-axial or “pipe within a pipe” venting system. The outer “pipe” or vent conducts fresh, outside air into the fireplace and the inner vent carries the exhaust outside. This system, which can run either horizontally through a side wall or vertically through the roof, produces an efficient system because conditioned building air is not used for combustion.

- Only the 5” x 8” direct vent components from the companies listed below are approved for use with these fireplaces. Any of the 5” x 8” direct vent components suitable for the local condition are permitted. Please visit www.europeanhome.com/qr-support or via the QR code below for installation instructions.
- This fireplace is shipped with a North American venting adapter. It MUST attach to the vent collar of the fireplace.
- All venting measurements are taken from the top center of the vent collar on the top of the fireplace and all configurations must fall within the acceptable range of the venting charts.
- A minimum clearance of 3”/75 mm must be maintained between combustible materials and the top of any horizontal vent pipe surface; a minimum clearance of 1”/25 mm must be maintained between combustible materials and any other vent pipe surface.
- The horizontal parts of the venting must be pitched up away from the fireplace. For every 12” / 305 mm of horizontal run, the venting must rise ¼” / 6.5 mm toward the termination. The venting must never run downward unless with the use of a power vent.
- Whenever venting passes through a wall, an approved heat shield or ‘wall thimble’ must be installed.
- A power vent system is available for venting that falls outside of the venting graphs. Refer to the appropriate power vent manual for any venting configuration which is outside of the vent graphs shown here.
- Your venting needs to be inspected annually, including any connected components, to ensure that the system is working as designed.
- In colder climate environments, the fireplace can be lowered to STANDBY MODE (Pilot Flame only). This will help maintain a steady draft within the venting over a period of up to (5) days. See the “Operating the Fireplace” section.

APPROVED MANUFACTURERS and COMPONENTS
M&G DuraVent, Inc.
EXCELDirect (ICC - Industrial Chimney Company)
Pro-Form (BDM - Bernard Dalsin Manufacturing)
Direct-Temp (Selkirk Corporation)
AmeriVent Direct Vent

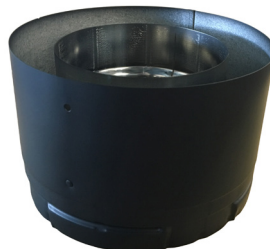

North American Vent Adapter

For the power venting installation manuals
please visit the link below.
www.europeanhome.com/qr-support



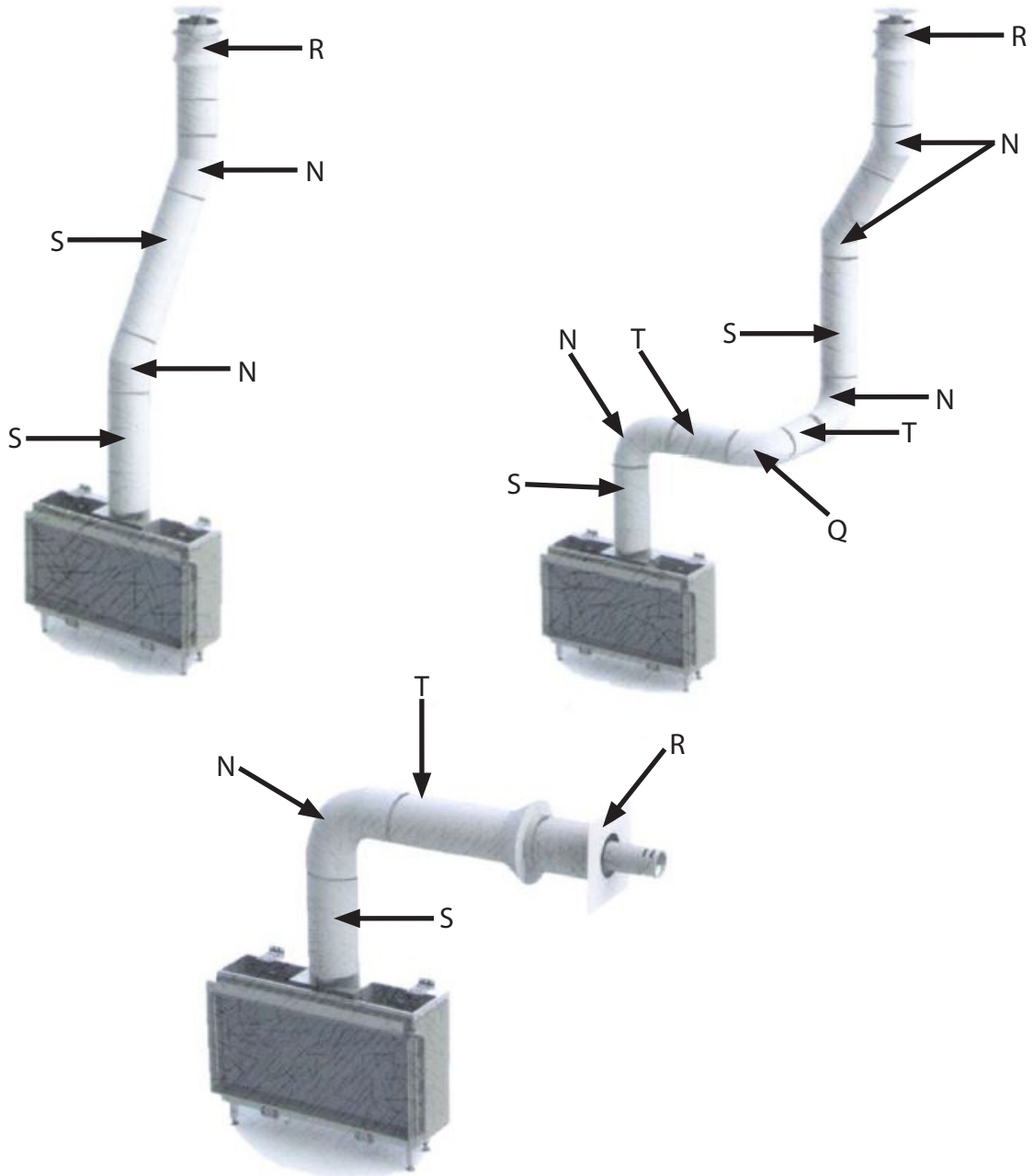

Vertical or Horizontal Vent Termination	R
45 or 90 degree bends Vertical to Horizontal or vice versa	N
45 and 90 degree bends Horizontal to Horizontal	Q
Horizontal Pipe Section	T
Vertical Pipe Section	S

CALCULATING THE TOTAL VERTICAL SECTION (TVS)

Calculate the Total Vertical Section by adding up all vertical upward sections in your specific vent design.

CALCULATING THE TOTAL HORIZONTAL SECTION (THS)

Calculate the Total Horizontal Section by adding up all horizontal sections in your specific vent design.

BEWARE OF ELBOWS

Elbows do not help the movement of air through your venting configuration and must be included when determining your minimum and maximum vent lengths.

45° elbows are calculated as either vertical or horizontal depending on positioning.

There are (2) types of elbows:

TYPE N 45° and 90° elbows from vertical to horizontal and vice versa

-The first (3) N elbows do not need to be included in venting calculations.

-For every extra N elbow, you must add 40"(1m) to your **THS**

TYPE Q 45° and 90° elbows from horizontal to horizontal

-For each 90° elbow in the horizontal section you must add 80"(2m) to your **THS**

-For each 45° elbow in the horizontal section you must add 40"(1m) to your **THS**

INTERPRETING THE GRAPH RESULTS

Once you have found your total vertical section (**TVS**) and your total horizontal section (**THS**) determine where you vent configuration will terminate on the corresponding venting chart (shown on the next page).

These venting numbers will correlate as follows:

0	venting possible, no restrictor needed
35	venting possible, 35mm restrictor needed
X	venting NOT possible

If your venting configuration lands on a block with an "X" the configuration is not possible.

For venting configurations that land on an "X" a power vent option may be available.

CALCULATING THE TOTAL VERTICAL SECTION (TVS)

Calculate the Total Vertical Section by adding up all vertical upward sections in your specific vent design.

CALCULATING THE TOTAL HORIZONTAL SECTION (THS)

Calculate the Total Horizontal Section by adding up all horizontal sections in your specific vent design.

INSTALLING A RESTRICTOR

Some vent configurations may require a restrictor plate be installed. The restrictor for this fireplace is installed on the inside top of the fireplace and is to be slid open or closed. Loosen the screws on either side and slide the restrictor as desired. Do not modify the restrictor(s). Please use the graph above to determine if you will need to use a restrictor.

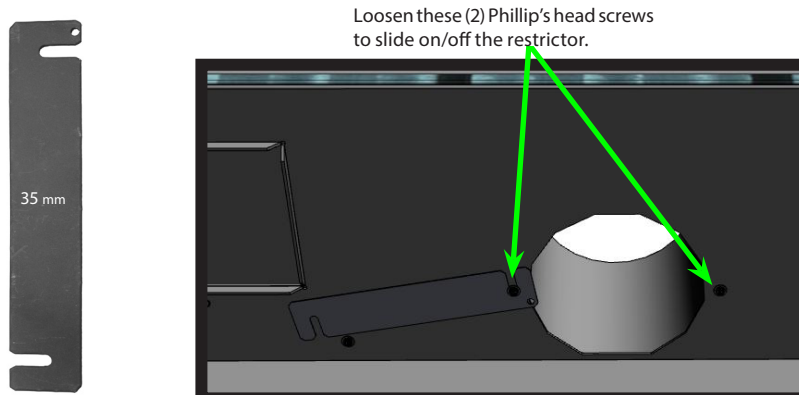

HORIZONTAL TERMINATIONS & RESTRICTOR USE

Category 3 - Horizontal Termination (vent possibilities & restrictor requirements)								
rise	32'10" (10 m)	35	35	35	0	0	x	x
	29'7" (9 m)	35	35	35	35	35	x	x
	26'3" (8 m)	35	35	35	35	35	0	x
	23' (7 m)	35	35	35	35	35	0	0
	19'8" (6 m)	35	35	35	35	35	0	0
	16'5" (5 m)	35	35	35	35	35	0	x
	13'2" (4 m)	35	35	35	35	35	x	x
	9'10" (3 m)	0	0	0	0	x	x	x
	6'7" (2 m)	0	0	0	x	x	x	x
	3'4" (1 m)	0	0	x	x	x	x	x
	1'8" (0.5 m)	x	x	x	x	x	x	x
	inches (meters)	0 - 1'7"	1'8" (0.5 m)	3'4" (1 m)	5' (1.5 m)	6'7" (2 m)	8'3" (2.5 m)	9'10" (3 m)
		run						

VERTICAL TERMINATIONS & RESTRICTOR USE

Category 3 - Vertical Termination (vent possibilities & restrictor requirements)								
rise	75'6" (23 m)	0	x	x	x	x	x	x
	72'3" (22 m)	0	0	0	x	x	x	x
	68'11" (21 m)	35	35	0	0	0	x	x
	65'8" (20 m)	35	35	35	35	35	0	0
	62'5" (19 m)	35	35	35	35	35	35	0
	60' (18 m)	35	35	35	35	35	35	0
	55'10" (17 m)	35	35	35	35	35	35	0
	52'6" (16 m)	35	35	35	35	35	35	0
	49'3" (15 m)	35	35	35	35	35	35	0
	46' (14 m)	35	35	35	35	35	35	0
	42'8" (13 m)	35	35	35	35	35	35	0
	39'5" (12 m)	35	35	35	35	35	35	0
	36'2" (11 m)	35	35	35	35	35	35	0
	32'10" (10 m)	35	35	35	35	35	35	0
	29'7" (9 m)	35	35	35	35	35	35	0
	26'3" (8 m)	35	35	35	35	35	0	0
	23' (7 m)	35	35	35	35	35	0	0
	19'8" (6 m)	35	35	35	35	35	0	x
	16'5" (5 m)	35	35	35	35	35	0	x
	13'2" (4 m)	35	35	35	35	0	x	x
	9'10" (3 m)	0	0	0	0	x	x	x
	6'7" (2 m)	0	0	0	x	x	x	x
	3'4" (1 m)	0	0	x	x	x	x	x
	1'8" (0.5 m)	x	x	x	x	x	x	x
	inches (meters)	0 - 1'7"	1'8" (0.5 m)	3'4" (1 m)	5' (1.5 m)	6'7" (2 m)	8'3" (2.5 m)	9'10" (3 m)
		run						

KEY

0	venting possible, no restrictor needed
35	venting possible, 35mm restrictor needed
	venting NOT possible

VERTICAL TERMINATION CLEARANCES AND REQUIREMENTS

Important Note for Roof Terminations

These instructions should be used as a guideline and do not supersede local codes in any way. Install venting according to local codes, these instructions, the current National Fuel Gas Code (ANSI Z223.1 in the USA) or the current standard of CAN/CSA-B149.1 in Canada.

Vertical Vent Termination Clearances

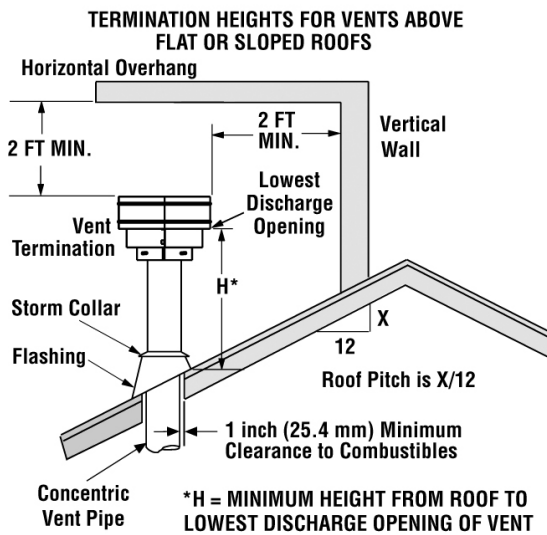

The vent / air intake termination clearances above the high side of an angled roof is as shown in the following chart:

Termination Heights For Vents Above Flat Or Sloped Roofs Ref. NFPA 54 / ANSI Z223.1		
Roof Pitch	* Feet	* Meters
Flat to 6/12	1.0	0.3
6/12 to 7/12	1.25	0.38
7/12 to 8/12	1.5	0.46
8/12 to 9/12	2.0	0.61
9/12 to 10/12	2.5	0.76
10/12 to 11/12	3.25	0.99
11/12 to 12/12	4.0	1.22
12/12 to 14/12	5.0	1.52
14/12 to 16/12	6.0	1.83
16/12 to 18/12	7.0	2.13
18/12 to 20/12	7.5	2.29
20/12 to 21/12	8.0	2.44

Termination Heights

A second termination may be no closer than 12"/305 mm.

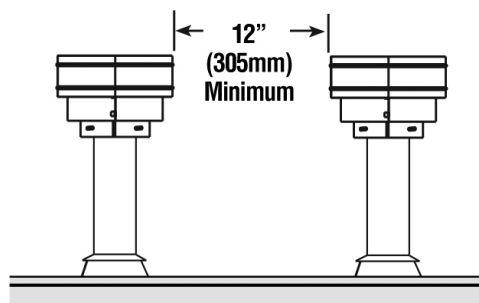

Multiple Termination Clearance

ENCLOSING the FIREPLACE

COMBUSTIBLE MATERIALS

Materials that can catch fire and burn are considered combustible. Any material that is made of, or faced with, wood, wood pulp, paper, plastic or any other material that can catch fire and burn is considered combustible. Even though these materials may have been 'flame-proofed', made 'fire-resistant' or are 'fire-rated' they are considered combustible. **Standard and Type X drywall are both combustible.**

NON-COMBUSTIBLE MATERIALS

A material is said to be non-combustible when it cannot catch fire and burn. For example, materials made entirely, or in combinations, of, stone, brick, concrete, tile, steel, plaster or glass are considered non-combustible.

The table below shows a list of materials which, as of this writing, are reported by their manufacturers to be non-combustible (in accordance with the ASTM E136 standard) **AND** approved for use around fireplaces.

Skamol Skamotec® 225 and the Promat PROMAFOUR® system are preferred products for enclosing fireplaces.

<i>Product</i>	<i>Thickness</i>
Skamol Skamotec® 225 Fireplace Building Board	1½"/38 mm
Promat PROMAFOUR® System	½"/12 mm, ⅝"/15 mm, ¾"/18 mm
James Hardie Building Products HardieBacker® 500 ½" Cement Board	½"/12 mm
James Hardie Building Products HardieBacker® ¼" Cement Board	¼"/6 mm

** The listed brand names are trademarks of their respective companies*

Skamol Americas, Inc.
(844) 475-2665
E-mail: skamotec225@skamol.com
www.skamotec225.com

Promat Inc.
(865) 681-0155
E-mail: sales@promat.us
www.promat.us/en

James Hardie Building Products
(888) 542-7343
www.jameshardie.com

ENCLOSING the FIREPLACE

BUILDING THE ENCLOSURE

A safe installation of your Element4 fireplace requires that four things be clearly understood.

1. Most important, these fireplaces are NOT zero-clearance fireplaces. Unlike zero-clearance fireplaces, there is not a metal box around the Element4 fireplaces. With no metal box there are no louvers to distract your view of the fire. However, we want the cooling advantage of a metal box so your site-built, non-combustible enclosure will substitute.
2. Your fireplace enclosure must be made to *act* the way a metal fireplace box acts - letting room air in below and warm convection air out above. The framing cannot interfere with the air flow. The *Room Air Inlet* is part of the fireplace and cannot be changed or adjusted. The convection air outlet is part of your enclosure design, is provided by you and **MUST** be included. **Note!** *The convection air outlet must be installed in the same room as the fireplace or a space which ALWAYS flows air into the room in which the fireplace is installed. The flow of convection air must NOT be blocked.*
3. Since these are not zero-clearance fireplaces, the clearances and dimensions listed in the **CLEARANCES** section **MUST** be maintained. Only the non-combustible wall, the mounting brackets and the venting may touch the fireplace. As previously stated, **NOTHING** may be built closer than 2"/50 mm to the non-glass sides.
4. The controls will be mounted to your enclosure and below the burner. The controls are at the end of a 50"/1270 mm line set and are to be mounted to the Wall Access Door which is included. The controls must be located for ease of physical access (gas line, maintenance, etc.) as well as wireless signal (remote control) access. See the **LOCATING THE CONTROLS** and the **MOUNTING THE CONTROLS** sections.

The combination of multiple glass sides and no zero-clearance box makes for a non-typical enclosure project. It may seem straightforward to build the 'rough opening', set the fireplace then attach the wall. However, **for most projects**, it will be easier to first set the fireplace in position then enclose it with Skamol Skamotec® or Promat PROMAFOUR® building board.

REDUCED CLEARANCE TO EXISTING COMBUSTIBLE WALLS

When retrofitting the fireplace against an existing wall it is often desirable to reduce the distance between the fireplace and the combustible wall. Normally, this distance is 11"/280 mm but it may be reduced by shielding the existing finished wall with a 1" air gap and a sheet of non-combustible material as shown on the following page.

IN ALL CASES:

- **A reduced clearance shield is ONLY ALLOWED ON A VERTICAL WALL; IT IS NOT ALLOWED TO BE USED ON OTHER SURFACES WITHIN THE NON-COMBUSTIBLE ZONE.**
- **The shield shall be placed no closer than 1"/25 mm to the floor or any intersecting walls. Air MUST be allowed to continually circulate around all sides of the wall shield.**
- **A 1"/25 mm air gap between the wall shield and the existing wall MUST be maintained.**
- **A 2"/50 mm air gap between the wall shield and the fireplace MUST be maintained.**

ENCLOSING the FIREPLACE

REDUCED CLEARANCE TO EXISTING COMBUSTIBLE WALLS

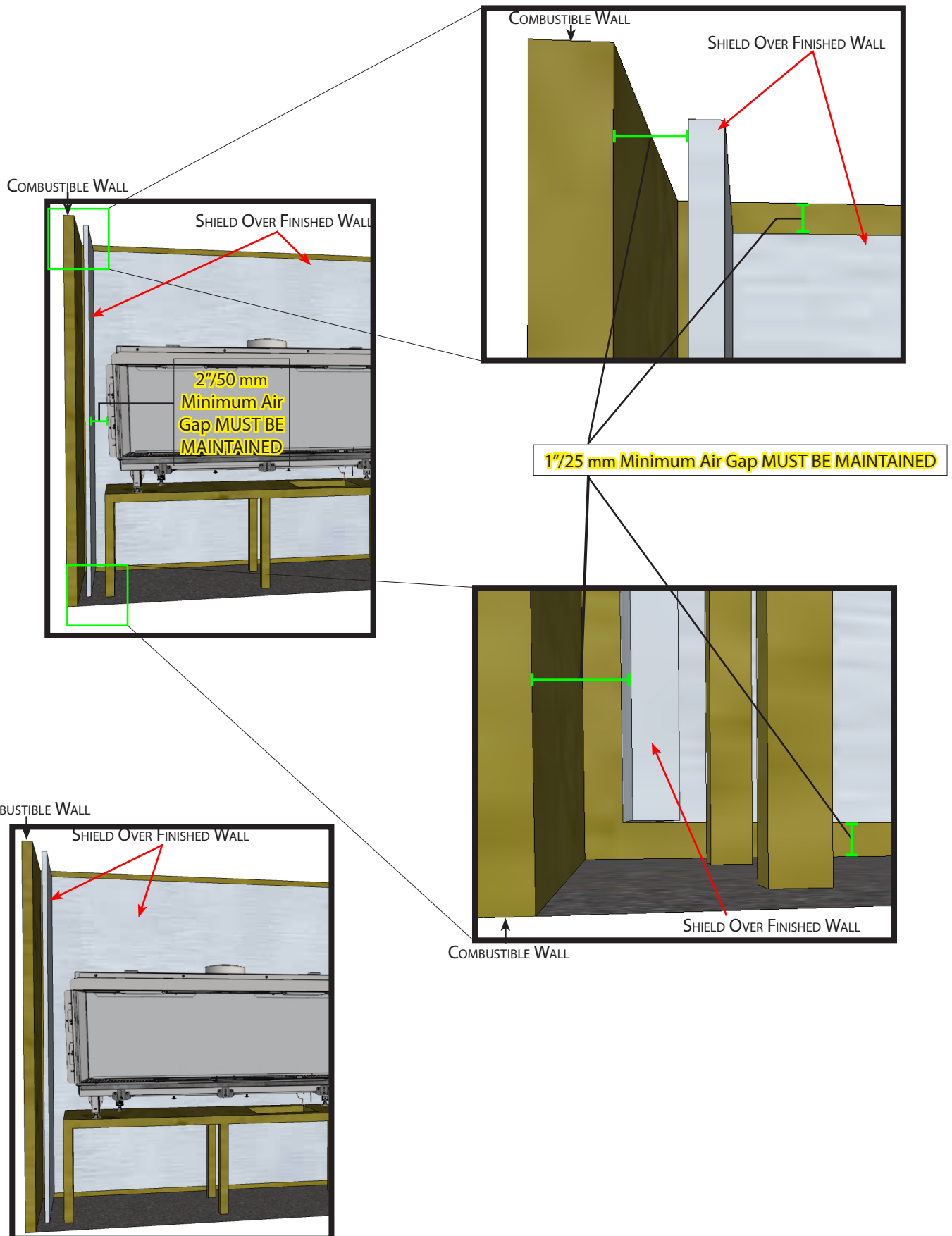

MINIMUM AREA REQUIRED FOR MODORE 185

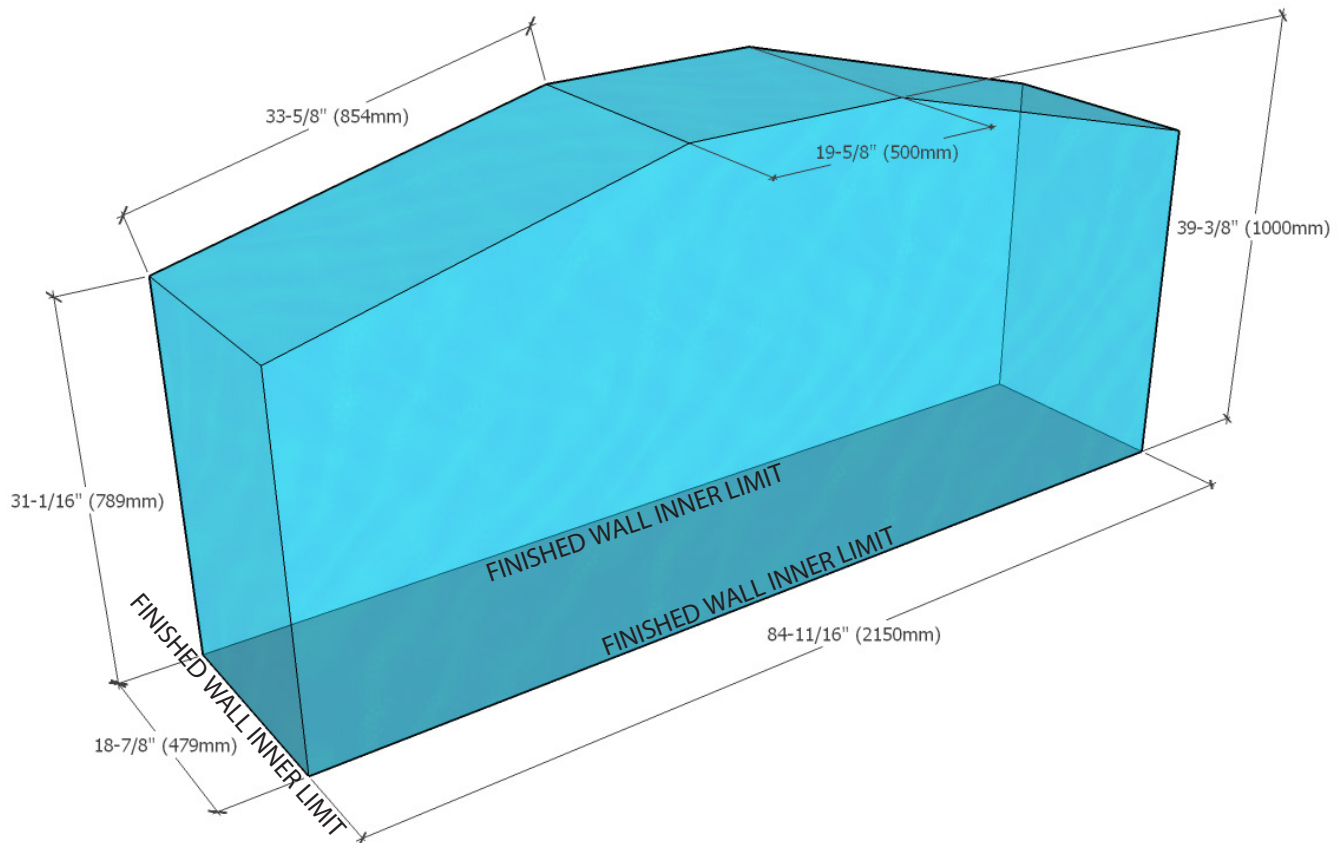

When enclosing the Modore 185 fireplace there is a minimum clear area which must be maintained. Nothing except the Modore 185 may be within this area. When enclosed, the Modore 185 is flush with the front wall - stand off frame in line with the front inside or back inside blue limit- above. This minimum area ***MUST BE DEFINED BY NON-COMBUSTIBLE MATERIAL***. The inside of the enclosing walls (including any necessary framing) may be no less than the distances shown above.

We recommend that the fireplace be set into its final location before building the enclosure.

ENCLOSING the FIREPLACE

The finished wall(s) must be at least ½"/12 mm thick or the fireplace trim will extend beyond the finished wall. The list below shows the thickness of the approved wall products.

Your choice of wall material depends largely on the intended finish. For example, a thinner wall product and a layer of stone may be thick enough to reach the trim edge. If a painted finish is desired then a wall at least ½"/12 mm thick will suffice.

Product	Thickness
Skamol Skamotec® 225 Fireplace Building Board	1½"/38 mm
Promat PROMAFOUR® System	½"/12 mm, ⅝"/15 mm, ¾"/18 mm
James Hardie Building Products HardieBacker® 500 ½" Cement Board	½"/12 mm
James Hardie Building Products HardieBacker® ¼" Cement Board	¼"/6 mm

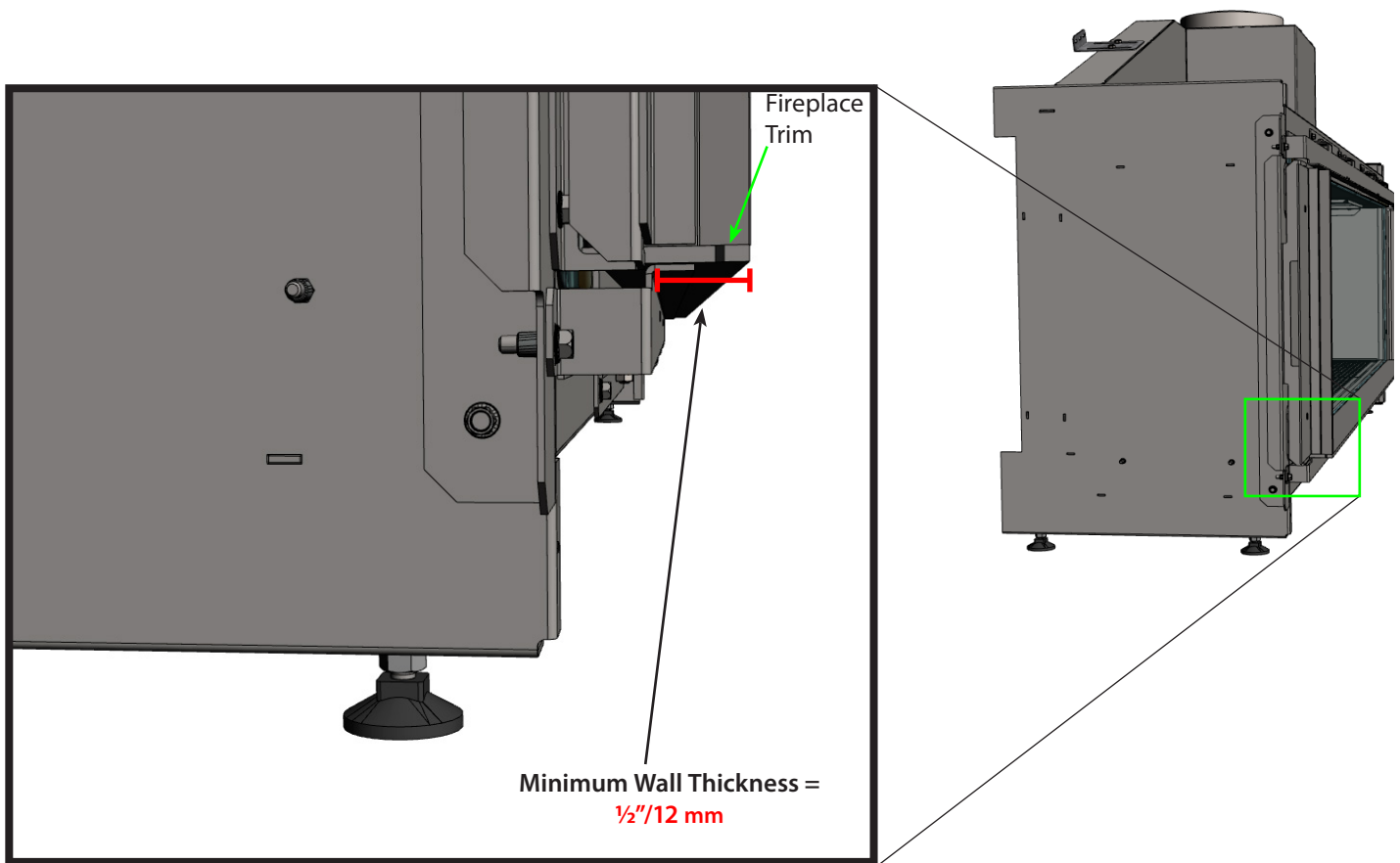

ENCLOSING the FIREPLACE

CONVECTION AIR OPENING

A convection air outlet is always required. The opening size of the convection air outlet varies by fireplace model. The **CLEARANCES** section shows the minimum total area required for the various models in this manual. The convection air outlet may take many forms and must always allow the free flow of warm air up through the chase and out into the room in which the fireplace is installed. Shown here are a number of ways to design the convection air outlet into your project.

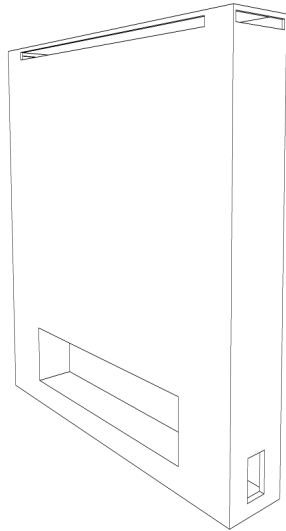

*Modore 185 with
Wall Outlets*

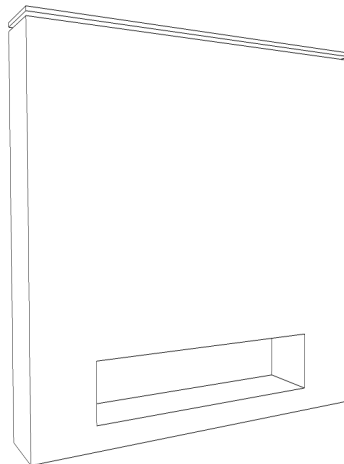

*Modore 185 with
Outlet in Reveal*

Convection Air Outlet Area by Model		
<i>Model</i>	<i>Square Inches</i>	<i>Square Centimeters</i>
Modore 185	126	813

ENCLOSING the FIREPLACE



**DO NOT ALLOW THE FIREPLACE
TO BEAR ANY WEIGHT**



Dimension A, B, and C must be equal throughout the installation.

Any support framing (NON-combustible framing ONLY) must be at least 2"/50 mm away, above and beside the fireplace. The entire weight of the non-combustible walls must be borne by a structure other than the fireplace.

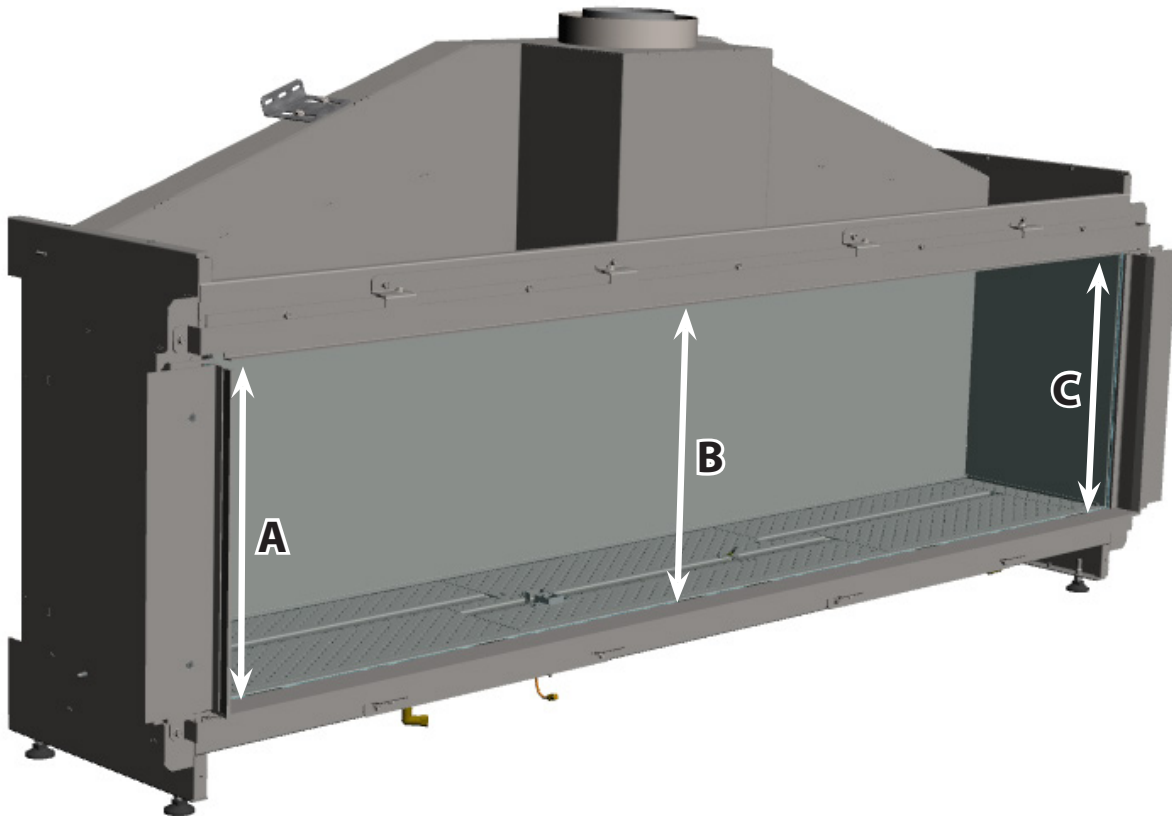

ENCLOSING the FIREPLACE

COLD CLIMATE INSULATION

For cold climate installations, it is especially important to insulate outside the chase cavity, between studs and under the floor on which appliance rests, if floor is above ground level. Gas line holes and other openings should be filled with approved firestop.

If the fireplace is being installed on a cement slab in cold climates, a sheet of plywood or a raised platform can be placed underneath to prevent cold transferring to the fireplace and into the room. It also helps to tape the venting for maximum air tightness and to caulk firestops.

LOCATING THE CONTROLS

The control system for the Element4 fireplaces consist of **three major components**:

- the receiver
- the remote
- the gas valve

The remote is the remote control by which you operate the fireplace. The receiver and the gas control are at one end of a line set which will extend approximately 50"/1270 mm from the *center* of the fireplace. The other end of the line set is connected to the firebox just left of center. As shipped, the line set is wrapped together and fixed beside the fireplace.

The Wall Access Door is provided with your fireplace and is designed to hold the receiver and gas control. When locating the Wall Access Door you must consider four types of access:

1. *Air access.* Room air must be allowed to flow freely through the door perforations, up through the site-built platform and above, through the enclosing fireplace chase.
2. *Line set access.* The line set is to be unwrapped which allows the controls to be then placed within approximately 50"/1270 mm from the center of the fireplace, *as the cable runs.*
3. *Physical access.* The gas valve/receiver must be readily accessible for maintenance, etc.
4. *Wireless access.* The signals from the remote must get to the receiver, inside the access door.

If the Access Door is not used its air access equivalent (25 square inches) as well as line set, physical and wireless access must be provided.

MOUNTING THE CONTROLS

Do not place the controls above the level of the burner. If the fireplace is to set directly on the floor, the controls must be placed outside the non-combustible zone or insulated from the heat from the fireplace.

The Wall Access Door (11¼"/286 mm high x 8⅞"/214 mm wide outer frame) requires a rough opening of 9⅓"/250 mm high x 6⅝"/175 mm wide. The door should be mounted with the hinge on the left side or with the hinge side down.

Wall Access Door Dimensions	
<i>Outer Frame</i>	<i>Rough Opening</i>
11¼"/286 mm x 8⅞"/214 mm	9⅓"/250 mm x 6⅝"/175 mm

ENCLOSING the FIREPLACE

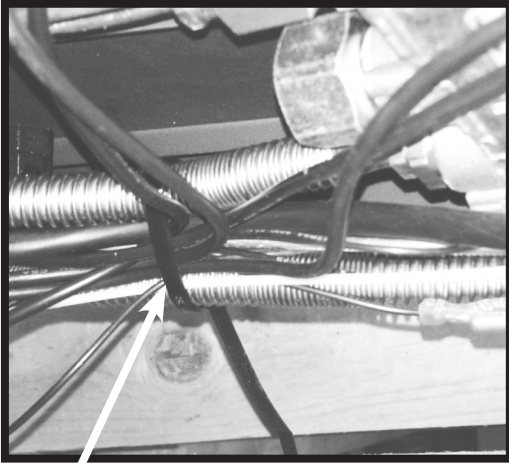

Carefully cut the black tie wraps which hold the line set to the bottom of the fireplace then carefully unwrap the line set. Lay the line set out towards the location of the Access Door. Do not kink the lineset and do not bend to a radius of less than 2"/50 mm.

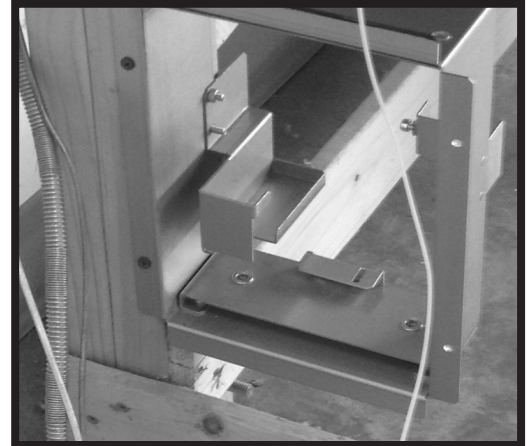

Remove the four bolts holding the white door/frame cover to the frame. Separate the frame and cover then mount the Access Door frame to the rough opening as shown.

Replace the white door/frame cover onto the frame and secure it with the four bolts.

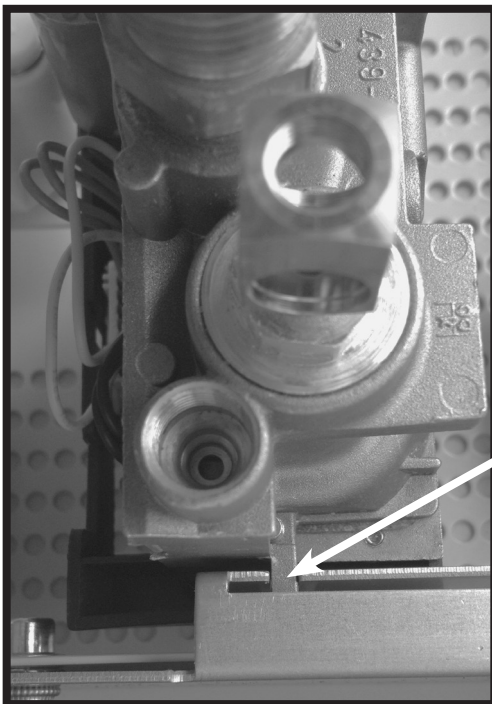

Fit the gas control tab into the bracket on the Access Door frame.

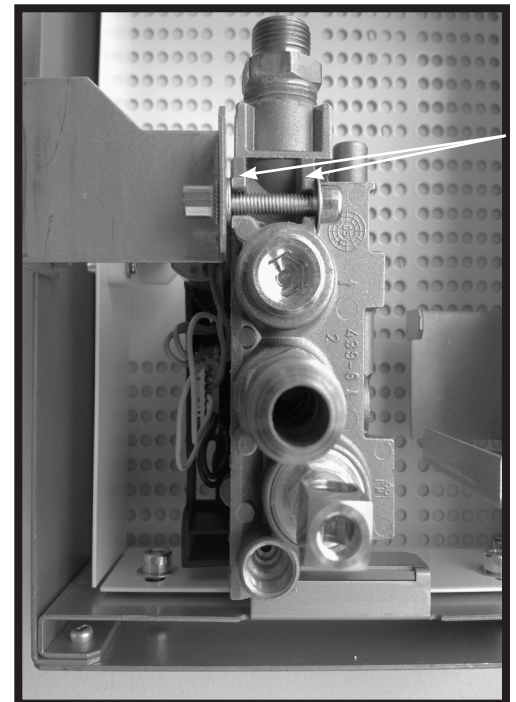

Tighten the bolt through the mounting bosses.

ENCLOSING the FIREPLACE



Set the receiver into the Wall Access Door bracket as shown and connect the AC adapter.

Wall Access Door with gas control and receiver mounted.

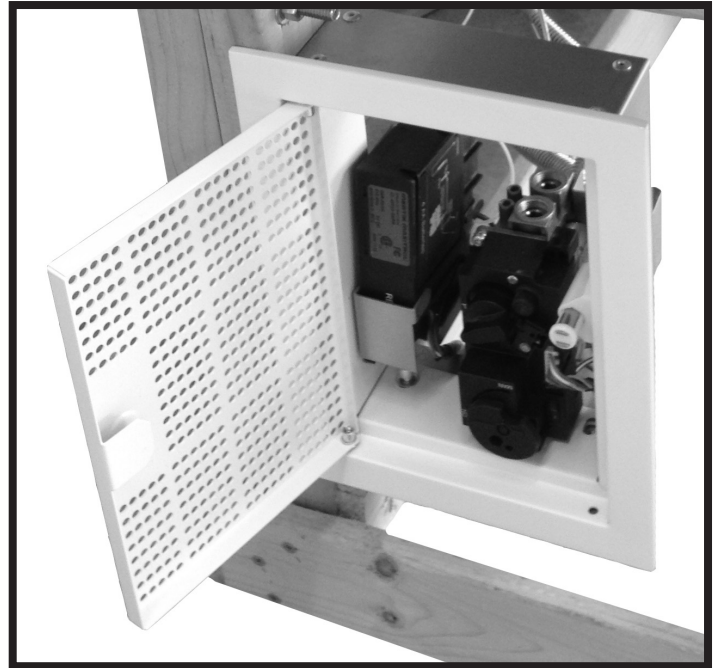

TEST FIRE

Prior to being placed into operation, the fireplace should be test-fired in stages to ensure that all components are in good working order. This fireplace has a 2nd thermocouple which senses the main burner flame. The system will turn itself off if the system does not sense the 2nd thermocouple output within 20 seconds after the main valve opens.

Note that a single, long beep indicates that the 2nd thermocouple is still hot enough to produce electricity at the receiver which will not allow the fireplace to start. Allow time for the 2nd thermocouple to cool down before attempting a start. The system is ready to start when pressing the ON/OFF button produces a response from the valve.

1. Start the fireplace with the hearth panel out and with the front glass off. Ensure that the pilot flame both heats the primary thermocouple and lights the main burner. For safety, a post-purge delay is built into the system. Subsequent start attempts **MUST NOT** take place for at least thirty (30) seconds.
2. Start the fireplace with the hearth panel in place and with all of the glass panels fixed correctly in place. Ensure that the main burner flames engulf the 2nd thermocouple and the fireplace stays lit for at least 1 full minute. If the system turns itself off after 20 seconds install the required media (next section) and return here. Installing the fire media will help with the flame around the 2nd thermocouple. Subsequent start attempts **MUST NOT** take place for at least five (5) minutes.
3. Start the fireplace with the media installed. If the system turns itself off after 20 seconds, rearrange the media to produce a good flame at the 2nd thermocouple. This step may have to be repeated several times before the media is in the best place for consistent operation. A single, long beep indicates that the 2nd thermocouple is still too hot to start the ignition sequence. Allow time for the 2nd thermocouple to cool down. Once the system stays lit for at least one full minute, turn the fireplace off, fix the glass panels in place and operate the fireplace for at least 45 minutes to ensure the system works properly when heated.

LOG ARRANGEMENTS

Ensure that the hearth panels are properly placed and sitting firmly on the base of the fire box. The pilot flame must be visible through the panel and the cut-out in the pilot shield. Scatter the bag of chips evenly on the hearth panel and burners. Ensure that the area inside the pilot shield and the area around the 2nd thermocouple remains clear of media.



- What's in the box? (LSE 420 II)**
- (2) small bags of ash (optional use)
 - (2) pine cones
 - (14) logs
 - bags of black & grey chips

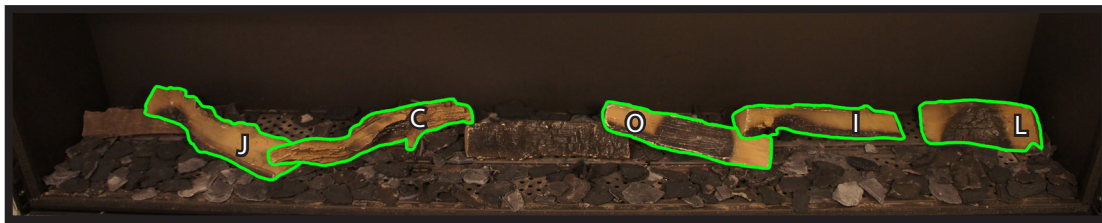

INSTALLING THE FIRE MEDIA

STONES/GLASS ARRANGEMENTS

Ensure that the hearth panel is sitting firmly on the base of the fire box and the shield is installed around the 2nd thermocouple. The center panel must be inserted in between the burner tubes. The pilot flame must be visible through the hearth panel and the pilot shield.

Evenly scatter the contents of the bag of stones/glass over the top of the hearth panel and burner. Ensure that none of the stones/glass enters the pilot area or restricts the operation of the 2nd thermocouple.

The arrangement is now complete. However, it is important to check that the pilot flame is still visible.

A shows the arrangement for stones; the arrangement for glass is similar.



*(actual burner pilot assembly and thermocouple location may vary depending on model)
(grey stones shown here)*

B shows the pilot area (below) clear of media (above).

C shows the 2nd thermocouple area (below) clear of media (above).

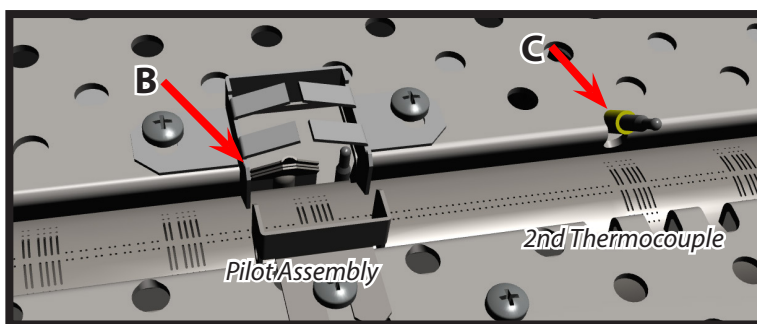

To see how to arrange media in an Element4 fireplace please visit the link below.

WWW.EUROPEANHOME.COM/RESOURCES/VIDEOS/



SCREEN INSTALLATION

MODORE 185	
Upper Tabs	3
Lower Tabs	3
Magnets	9
Long Screen	1
Short Screen	N/A

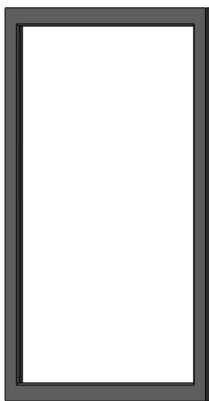
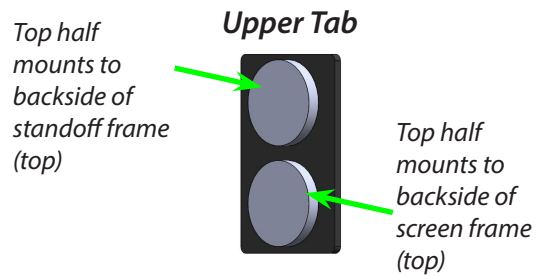
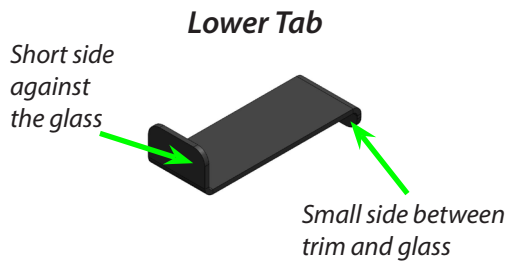

Short Screen



Long Screen

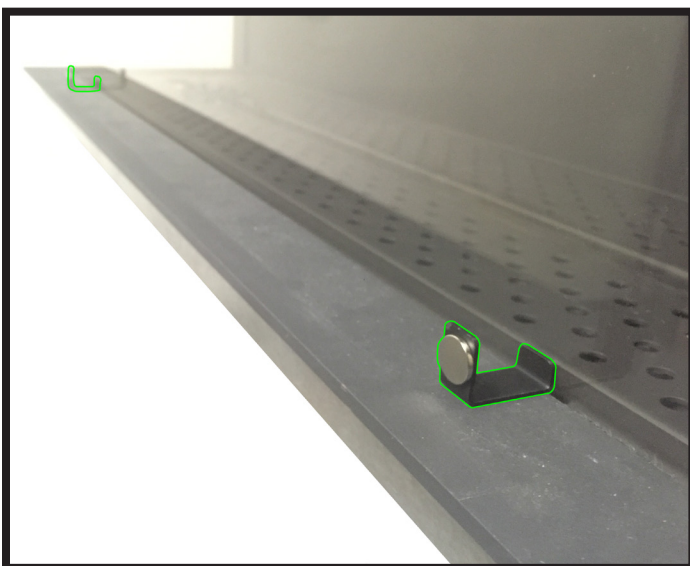

Place the (2) Lower Tabs on the trim, with the short side against the glass, ~2-3" from each corner of the glass. Place a magnet on the front of each tab.

SCREEN INSTALLATION



Place the (2) Upper Tabs on the inside of the top stand off frame. One magnet will be hidden, attached to the standoff frame. The other magnet will be exposed to attach to the screen.

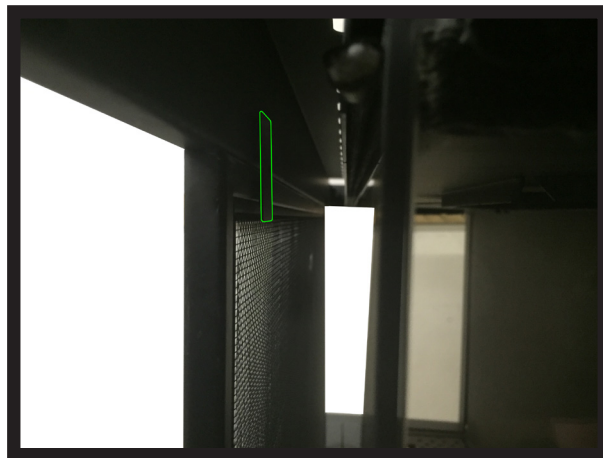

This is what the screen will look like when it is attached correctly to the top Upper Tabs (view from inside of the standoff frame).

SCREEN INSTALLATION

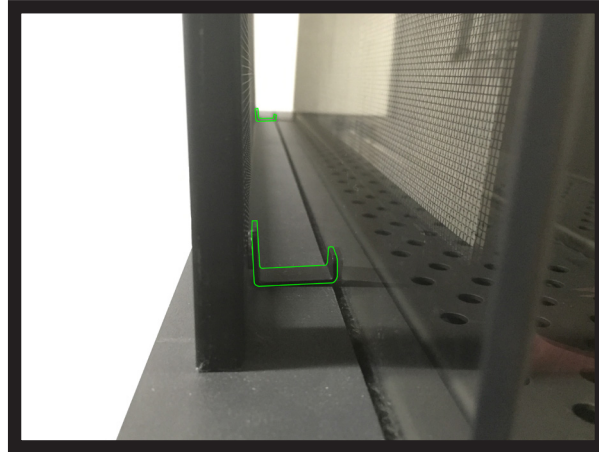

This is what the screen will look like when it is attached correctly to the top Lower Tabs (view between the screen and the glass).

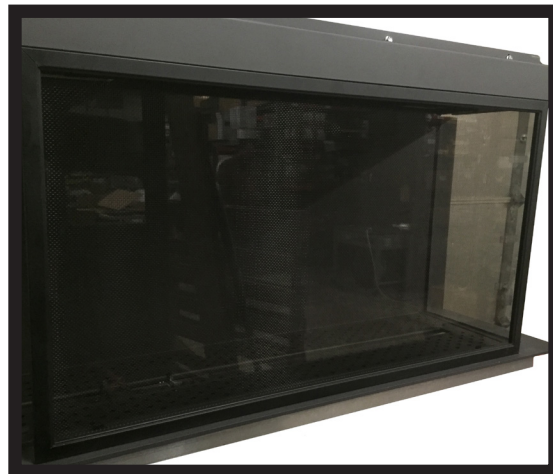

The screen is installed properly in the photo above. Please make sure that all magnets are in the correct position and the tabs are secured.

OPERATING the FIREPLACE

BEFORE THE FIRST FIRE

1. Make certain that all construction materials have been removed from inside and around the fireplace and the fireplace has been cleaned of any construction dust. Clean the glass BEFORE and AFTER the first fire.
2. Confirm that the gas valve is properly connected and bled by a certified gas technician or plumber.
3. Check the gas supply for leaks and proper pressure. --- Refer to the table in "Appliance Ratings" section.
4. Check that the venting is unobstructed and in proper working condition.
- 5. PROPERLY PLACE, CLAMP, AND SEAL THE GLASS PANELS.**
6. Ensure the receiver is plugged in with AC Adapter OR Batteries... NOT BOTH.
7. Place the (2) AAA batteries into the remote control and confirm that it will communicate with the receiver by pressing the ON/OFF button. If necessary pair the remote and receiver.
8. Follow USING THE REMOTE CONTROL ELECTRONIC IGNITION SEQUENCE to setup and use remote.

PAIRING THE REMOTE AND RECEIVER (System Reset)

From the factory, the remote control will communicate with the receiver; they are 'paired' and should need no further attention. If the receiver does not respond to commands from the remote they should be paired to each other. This is done as follows:

1. Press and hold the receiver reset button using a small, long tool until you hear the second of two beeps. After the second beep release the reset button.
2. Press and hold the ▼ button on the remote until you hear the second of two beeps. Release the ▼ button.

If you hear one long beep, this indicates the pairing sequence has failed or the wiring is incorrect.



Note! For normal operation the *MANUAL* knob on the gas valve cannot be in the *MAN* position; it must be fully in the *ON* position.

OPERATING the FIREPLACE

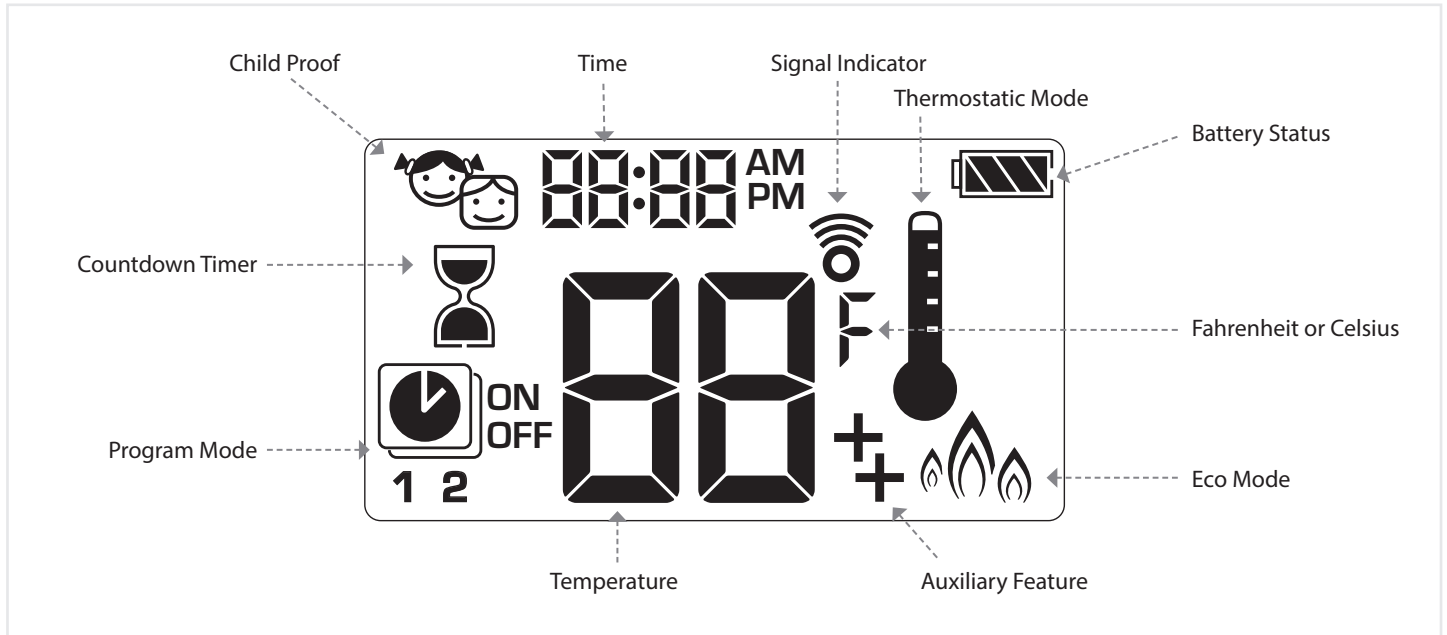

Display

SETTING FAHRENHEIT or CELSIUS

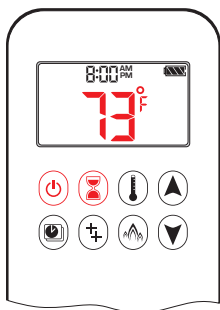

To change between °C and °F, press and buttons simultaneously.

NOTE: Choosing °F results in a 12 hour clock. Choosing °C results in a 24 hour clock.

CHILD PROOF

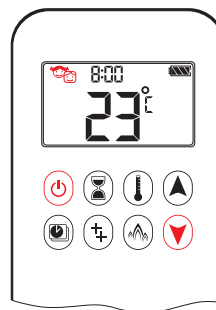

ON:
To activate, press and buttons simultaneously. displayed and the remote is rendered inoperable, except for the off function.

OFF:
To deactivate press and buttons simultaneously. disappears.

SETTING the TIME

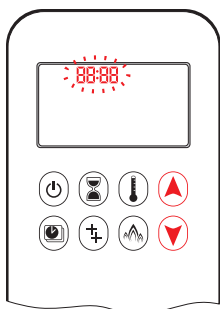

1. Press and buttons simultaneously. Day flashes.
2. Press or button to select a number to correspond with the day of the week (e.g. 1=Monday, 2=Tuesday, 3=Wednesday, 4=Thursday, 5=Friday, 6=Saturday, 7=Sunday).
3. Press and buttons simultaneously. Hour flashes.
4. To select hour press or button.
5. Press and buttons simultaneously. Minutes flash.
6. To select minutes press or button.
7. To confirm press and buttons simultaneously or wait.

MANUAL MODE (REMOTE)

NOTICE

BEFORE OPERATING

1. Make sure MANUAL knob on the valve is in the ON, full counterclockwise position.
2. Place the ON/OFF switch (if equipped) in the I (ON) position.

TO TURN ON FIRE

PLEASE SEE NEXT PAGE FOR FURTHER INSTRUCTIONS

⚠ WARNING

When pilot ignition is confirmed, motor turns automatically to maximum flame height.

OPERATING the FIREPLACE

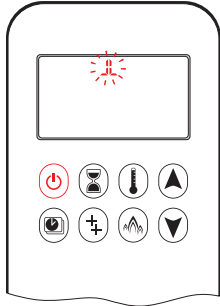

Remote One-Button Operation (Default Setting)

- Press and hold button until two short beeps and a blinking series of lines confirms the start sequence has begun; release button.
- Main gas flows once pilot ignition is confirmed.
- Remote automatically goes into Manual Mode after main burner ignition.

NOTICE

Change from one-button to two-button ignition operation by pressing and holding button for 10 sec. immediately after installing batteries. **ON** is displayed and **1** is flashing. When change is complete **1** will change to **2**.

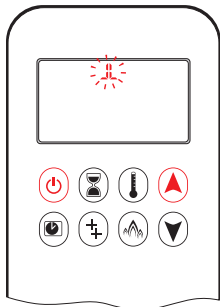

- ## Remote Two-Button Operation
- Press and button simultaneously until two short beeps and a blinking series of lines confirms the start sequence has begun; release buttons.
 - Main gas flows once pilot ignition is confirmed.
 - Remote automatically goes into Manual Mode after main burner ignition.

NOTICE

Change from two-button to one-button ignition operation by pressing and holding button for 10 sec. immediately after installing batteries. **ON** is displayed and **2** is flashing. When change is complete **2** will change to **1**.

⚠ WARNING

If the pilot does not stay lit after several tries, turn the main valve knob to OFF and follow the operating instructions "TURN OFF GAS TO APPLIANCE".

STANDBY MODE (PILOT FLAME)

Remote

- Press and hold button to set appliance to pilot flame.

TO TURN OFF FIRE

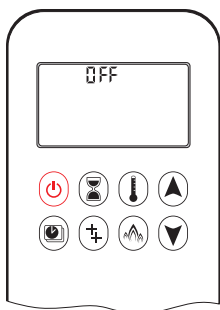

- Remote
- Press button to turn OFF.

NOTE: There is a 5 second delay before the next ignition is possible.

FLAME HEIGHT ADJUSTMENT

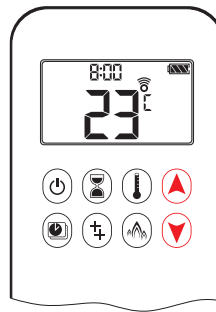

Remote

- To increase flame height press and hold button.
- To decrease flame height or to set appliance to pilot flame, press and hold button.

DESIGNATED LOW FIRE and HIGH FIRE

NOTE: Backlight must be on for high fire and low fire double-click operation.

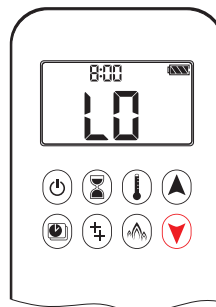

- To go to low fire, double-click button. **LO** is displayed.

NOTE: Flame goes to high fire first before going to low fire.

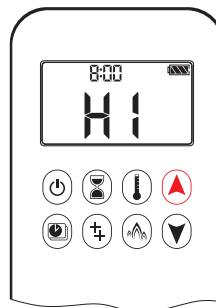

- To go to high fire, double-click button. **HI** is displayed.

⚠ WARNING

If the appliance will not operate, follow the instructions "TURN OFF GAS TO APPLIANCE".

COUNTDOWN TIMER

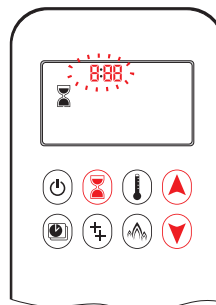

ON/SETTING:

1. Press and hold button until displayed, and hour flashes.
2. To select hour press or button.
3. To confirm press button. Minutes flash.
4. To select minutes press or button.
5. To confirm press button or wait.

OFF:

Press button, and countdown time disappear.

NOTE: At end of countdown time period, the fire turns off. The Countdown Timer only works in Manual, Thermostatic, and Eco Modes. Maximum countdown time is 9 hours and 50 minutes.

OPERATING the FIREPLACE

MODES of OPERATION

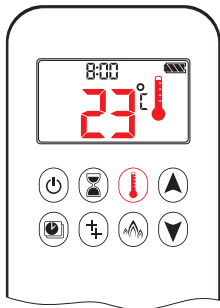

Thermostatic Mode
The room temperature is measured and compared to the set temperature. The flame height is then automatically adjusted to achieve the set temperature.

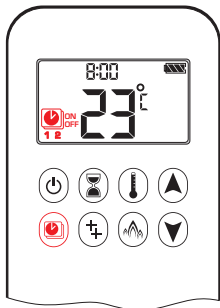

Program Mode
PROGRAMS 1 and 2, each can be programmed to go on and off at specific times at a set temperature.

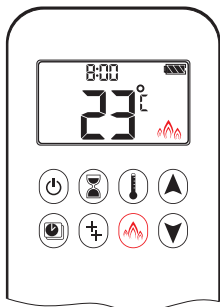

Eco Mode
Flame height modulates between high and low. If the room temperature is lower than the set temperature, the flame height stays on high for a longer period of time. If the room temperature is higher than the set temperature, the flame height stays on low for a longer period of time. One cycle lasts approximately 20 minutes.

THERMOSTATIC MODE

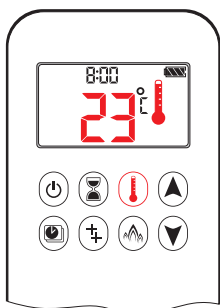

ON:
Press button. displayed, preset temperature displayed briefly, and then room temperature displayed.

OFF:
1. Press button.
2. Press or button to enter Manual Mode.
3. Press button to enter Program Mode.
4. Press button to enter Eco Mode.

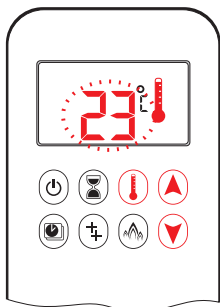

SETTING:
1. Press button and hold until displayed, temperature flashes.
2. To adjust set temperature press or button.
3. To confirm press button or wait.

PROGRAM MODE

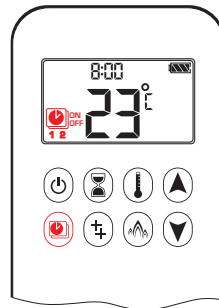

ON:
Press button. , **1** or **2**, **ON** or **OFF** displayed.

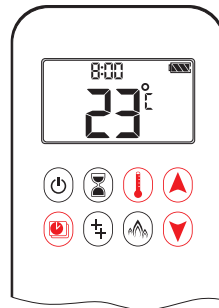

OFF:
1. Press or or button to enter Manual Mode.
2. Press button to enter Thermostatic Mode.

NOTE: The set temperature for Thermostatic Mode is the temperature for the on time in Program Mode. Changing the Thermostatic Mode set temperature also changes the on time temperature in Program Mode.

Default settings:
ON TIME (Thermostatic) TEMPERATURE: 21 °C (70 °F)
OFF TIME TEMPERATURE: "— —" (pilot flame only)

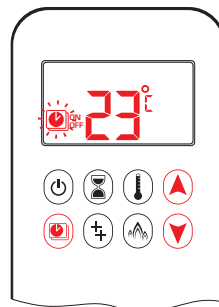

TEMPERATURE SETTING:
1. Press button and hold until flashes. **ON** and set temperature (setting in Thermostatic Mode) displayed.
2. To continue press button or wait. , **OFF** displayed, temperature flashes.
3. Select off temperature by pressing the or button.
4. To confirm press button.

NOTE: The on (Thermostatic) and off set temperatures are the same for each day.



DAY SETTING:
5. **ALL** flashes. Press or button to choose between **ALL**, **SUN**, **1**, **2**, **3**, **4**, **5**, **6**, **7**.
6. To confirm press button.

OPERATING the FIREPLACE

AUXILIARY FEATURE

RLL selected

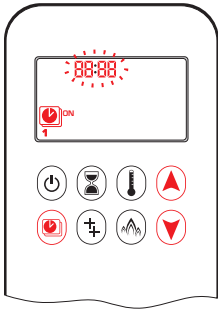

ON TIME SETTING (PROGRAM 1):

7. , **1, ON** displayed, RLL is displayed shortly, and hour flashes.
8. To select hour press or button.
9. To confirm press button. , **1, ON** displayed, RLL displayed shortly, and minutes flash.
10. To select minutes press or button.
11. To confirm press button.

Upon ignition burner 1 is on and burner 2 is in the last setting.

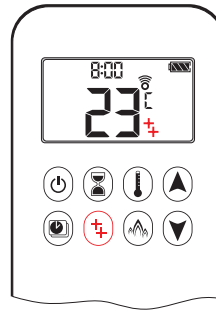

ON:

To switch a burner on, press the button. displayed.

OFF:

To switch the burner OFF, press the button. disappears.

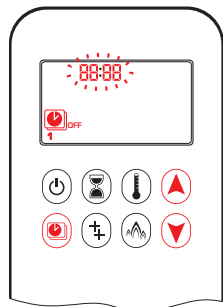

OFF TIME SETTING (PROGRAM 1):

12. , **1, OFF** displayed, RLL is displayed shortly, and hour flashes.
13. To select hour, press or button.
14. To confirm press button. , **1, OFF** displayed, RLL displayed shortly, and minutes flash.
15. To select minutes press or button.
16. To confirm press button.

NOTE: The latching solenoid valve cannot operate manually. If the receiver battery runs down it will remain in the last operating position.

ECO MODE

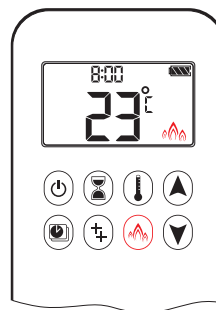

ON:

Press button to enter Eco Mode. displayed.

OFF:

Press button. disappears.

NOTE: Either continue to PROGRAM 2 and set on and off times or stop programming at this point, and PROGRAM 2 remains deactivated.

NOTE: PROGRAM 1 and 2 use the same on (Thermostatic) and off temperatures for RLL, 5R5U and Daily Timer (1, 2, 3, 4, 5, 6, 7). Once a new on (Thermostatic) and/or off temperature has been set, that temperature becomes the new default setting.

NOTE: If RLL, 5R5U or Daily Timer are programmed for PROGRAM 1 and PROGRAM 2 on and off times, these become the new default times. The batteries must be removed to clear the PROGRAM 1 and PROGRAM 2 on and off times and temperatures.

5R5U or Daily Timer (1, 2, 3, 4, 5, 6, 7) selected

- Set on time and off time using same procedure as "RLL selected" (above).
- 5R5U: Set on time and off time for both Saturday and Sunday.
- Daily Timer: Unique on and off times may be set for a single day of the week, for multiple days of the week, or for every day of the week.
- Wait to finish setting.

OPERATING the FIREPLACE

GENERAL NOTES

NOTICE

Wiring of valve and receiver must be completed before starting ignition. Failure to do so could damage the electronics.

Batteries – Remote

- Low battery indicator on remotes.

Batteries – Receiver

- Low battery indication: frequent beeps for 3 seconds when motor turns.
- Instead of batteries, the included AC adapter should be used for improved reliability and customer satisfaction.



⚠ WARNING

- Old or dead batteries should be removed immediately. If left in the unit the batteries can overheat, leak, and/or explode.
- Do NOT expose batteries (including during storage) to direct sunlight, excessive heat, fire, moisture, or severe impact. Each of these conditions can cause the batteries to overheat, leak, and/or explode.
- New and old batteries and different brands of batteries should not be used together. Mixing of various batteries can cause the batteries to overheat, leak, and/or explode.

Software Version

Press  and  buttons simultaneously. Software version is displayed.

Remote Model Number

Press  and  buttons simultaneously. Remote model number is displayed.

Deactivate Functions

1. Install batteries. All icons are displayed and flashing.
2. While the icons are flashing, press the relevant function button and hold for 10 sec.
3. The function icon will flash until deactivation is complete. Deactivation is complete when the function icon and two horizontal bars are displayed.

NOTE: If a deactivated button is pressed, there is no function, and two horizontal bars are displayed.



NOTE: Deactivation remains in effect after change of batteries.

Activate Functions

1. Install batteries. All icons are displayed and flashing.
2. To activate a function, press the relevant button and hold for 10 sec.
3. The function icon will continue to flash until activation is complete.

Activation is complete when the function icon is displayed.

The following Functions can be Deactivated/Activated

- CHILD PROOF (To activate press  and  buttons simultaneously.  displayed and the remote is rendered inoperable (except for off function).
- PROGRAM MODE
- THERMOSTATIC MODE (also deactivates Program Mode)
- ECO MODE
- LIGHT/DIMMER OPERATION
- CIRCULATING FAN OPERATION
- AUXILIARY FEATURE
- COUNTDOWN TIMER

Automatic Turndown.

1. In Manual/Temperature/Timer modes, the valve will turn to pilot flame if there is no change in flame height for a six hour period. In Temperature or Timer mode, if the ambient room temperature changes, the flame height will adjust automatically to maintain set temperature and the fire will continue to function normally. The valve will turn to pilot flame if the set temperature and the ambient room temperature remain the same over a six hour period.

2. The valve turns to pilot flame if the temperature in the receiver is higher than 140°F/60°C. The burners come back on only when the temperature is below 140°F/60°C.

Automatic Shut Off.

1. With low battery power in the receiver, the system shuts off the fire completely. This does not happen if the power supply is interrupted.

2. The system shuts off the fire completely if there is no change in flame height for 5 days.

3. The system shuts off the fire if the main burner does not completely ignite approximately 20 seconds after ignition or after pushing the  button.

OPERATING the FIREPLACE

THE FIRST FIRE

When the fireplace is first heated, an odor may be given off by the hot metal. This is normal and is a result of the 'burn off' of the lubricants and sealants used when manufacturing the fireplace. We recommend that you open the nearby windows for extra ventilation and then operate the fireplace for at least four hours.

When the glass is cold, some condensation may appear on the glass after lighting the fireplace. This is normal and the condensation will disappear as the glass warms.

During this first fire, examine the flame for appearance and quality. Examine the burner media for sooting. The flames should look like those shown below.

After this burn-off period, turn off the fireplace and let it cool completely to room temperature and clean both sides of the glass and the interior panels as described in the MAINTENANCE section.

Since it is a metal fireplace, the heat-up and cool-down cycles may produce some noises caused by the expansion and contraction of these metals. The premium materials and build quality of your fireplace will keep these sounds to a minimum.



To see an Element4 fireplace starting and running normally please visit the link below.

WWW.EUROPEANHOME.COM/RESOURCES/VIDEOS/



MAINTENANCE

REMOVING AND CLEANING THE GLASS

OVERVIEW

The glass panels are held in place by (2) rope gaskets. These instructions will show you how to remove and reinstall the glass panel.

Please read these instructions completely before proceeding.

TOOLS REQUIRED

- Gloves (not included)
- 1 Suction Cup (included)

REMOVING THE GLASS

Step 1.

Remove the three trim pieces; (2) sides and a bottom (magnetically attached) from the fireplace. There is no top trim. The trim pieces are held firmly in place with magnets and will simply lift out. The bottom (horizontal) trim is at the lower edge of the glass panels and the side (vertical) trim is where the glass meets the wall.

Step 2.

The glass panel(s) is held in place by two rope gaskets at the top and bottom edge of the fireplace.

Start at one end by gently pulling out the rope gasket.

Step 3.

Securely attach the suction cup to the center of the glass and lift the glass up into the clearance notch.

With the glass panel raised into the notch, swing the lower edge of the glass panel out towards the room and gently lower the glass towards the floor until it clears the fireplace.

PROPERLY PLACE GASKET AND SEAL THE GLASS PANEL(S) BEFORE LIGHTING THE FIRE!



MAINTENANCE

CLEANING THE GLASS

Burning natural gas (NG) or propane (LP) in this fireplace will always result in some of the gas components being deposited on the glass. Hydrogen sulfides and mercaptans, which are present in the burning gas, condense onto the relatively cooler glass surface and cause white film to build up over time.

The amount of this white film is influenced by a number of factors such as; the configuration of the system venting, thermal efficiency of the fireplace design, the humidity of combustion air, frequency of fireplace use, burner performance and, the fireplace design itself.

Do not use normal household (usually ammonia-based) glass cleaners to clean the glass as these cleaners can leave a permanent stain. Only a gas fireplace glass cleaner should be used. Products such as Stove Bright® Gas Appliance Glass Cleaner by Forrest Technical Coatings, Imperial Gas Fireplace Glass Cleaner by Imperial Manufacturing Group and GFC™ Gas Fireplace Glass Cleaner by A.W. Perkins Co. are designed for this purpose.

Follow the instructions for use and **do not clean the glass when it is hot!** If the glass becomes coated with deposits which cannot be removed it must be replaced.

The fireplace glass should be cleaned before the fireplace is first lit and then after the fireplace has been through its four hour burn-in cycle. This will reduce potential build up on your glass.

RE-INSTALLING THE GLASS

The glass panel(s) must be installed in reverse order of their removal.

Step 1.

Securely attach the suction cup to the center of the glass and lift the glass up into the clearance notch. Set the glass down once it has cleared the bottom frame.

Step 2.

Center the glass panel, left and right, on the fireplace then place the center of the top rope gasket in the center of the fireplace, between the glass and the frame.

Gently push the rope into the groove between the glass and the frame until the entire gasket is in place.

Repeat for the remaining lower rope gasket.

Step 3.

Replace the bottom long trim first, noting the placement of the tabs and slots. After, replace the side trims which are secured with magnets.

PROPERLY PLACE GASKET AND SEAL THE GLASS PANEL(S) BEFORE LIGHTING THE FIRE!

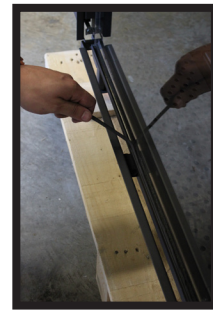

MAINTENANCE

WARNING

Installation and maintenance must be performed by an authorized qualified installer, service agency or gas supplier.

TURN OFF THE GAS before servicing the appliance. It is recommended that a qualified service technician perform an appliance check-up/service once a year.

Any safety screen or guard removed for servicing **MUST BE REPLACED** before operating this appliance.

DO NOT USE this appliance if any part has been under water. Immediately call a qualified service technician to inspect the unit and to replace any part of the control system and any gas valve that has been under water.

Any alteration to the product that causes soot or carbon to form and results in damage is not the responsibility of the manufacturer.

Inspect the external vent cap on a regular basis to make sure that no debris, plants, trees, or shrubs are interfering with the air flow.

BURNER MAINTENANCE

The flames from the burner should be visually checked. The flame should have a blue base and yellow tops and be candle-like in appearance.

PILOT MAINTENANCE

The pilot flame must be visually checked. The pilot flame must always be present when the appliance is in operation and should appear as shown (with hearth panel removed.)

The pilot has two distinct flames, one engulfing the thermocouple on its left, the other reaching across to the main burner.

The area around the pilot should be inspected for cleanliness. Lint or foreign material must be removed with a brush or vacuum.

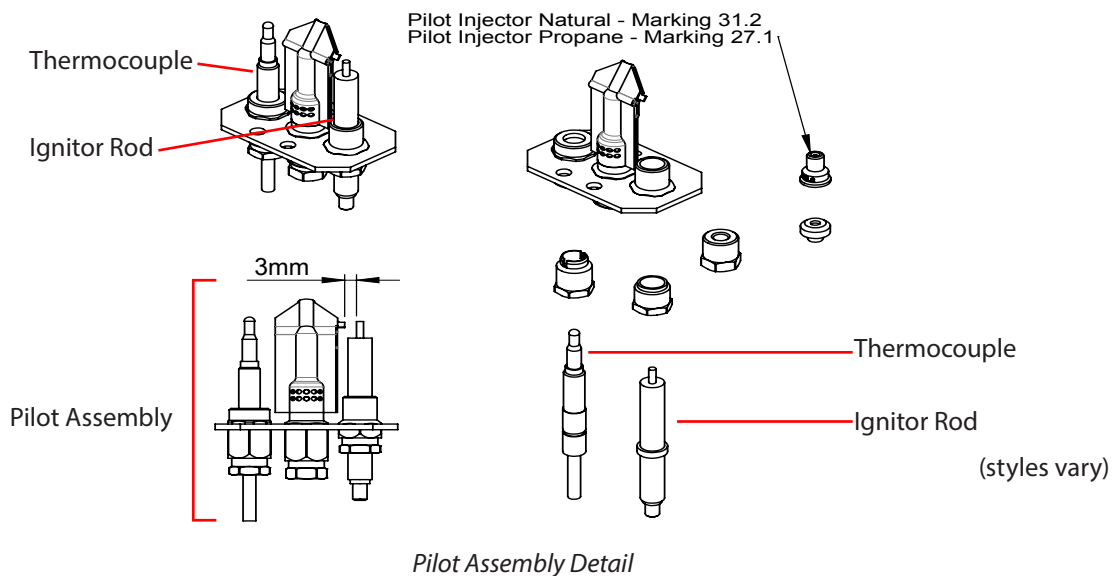

MAINTENANCE

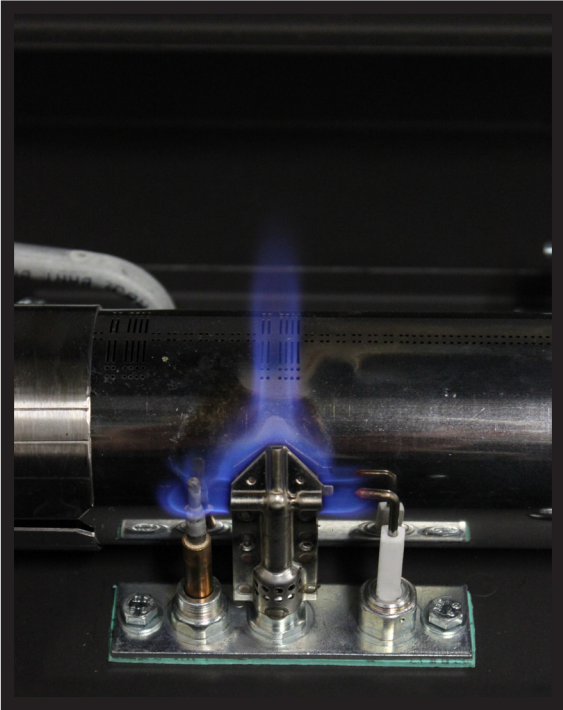

THERMOCOUPLE MAINTENANCE

The Element4 fireplaces have two thermocouples; one next to the pilot and one opposite the pilot side of the main burner. The completeness and operation of both must be checked. A qualified installer must confirm that both thermocouples are in place and not damaged. While checking the thermocouple, please ensure that the ignitor rod is not cracked as well.

VENT MAINTENANCE

The following venting system inspection by a qualified service technician is recommended every six months:

1. Inspect for excessive condensation, e.g. water droplets forming in the inner lining and subsequently dripping out of the joints. This can cause corrosion in the system.
2. Check for corrosion in areas exposed to the elements. Where rust spots or holes have appeared, these must be immediately replaced.
3. Ensure that there is no foreign material in the vents. Survey by removing the cap and shining a light down the vent.
4. Check all joints and pipes to make sure that nothing has been disturbed or loosened.

REPLACEMENT PARTS

The replacement parts list is shown below.

REPL-E4-GS-1T-01
REPL-E4-GS-2TC-01
REPL-E4-GS-CMESAVE-01
REPL-E4-GS-RCESAVE-01

Replacement Primary Thermocouple
Replacement 2nd Thermocouple
Replacement Receiver
Replacement Remote Control

PROPANE (LP) CONVERSION KIT

In order to convert from Natural Gas (NG) to Propane (LP) an LP Conversion Kit will be needed. This kit will include the required orifices and an installation guide on how to complete the conversion. This conversion can only be completed by a certified installer or gas technician. The orifice for the burners is shown below. The **NG** orifices are marked 560 & 650, **LP** orifices are marked 220.

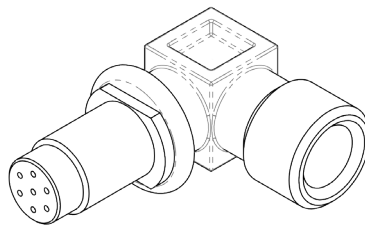

E4-SA-LPCK-Triple Burner

LP Conversion Kit

WARRANTY

European Home Warranty Element4 Gas Fireplace

European Home warrants these gas fireplaces against defects in materials and workmanship for a period of ONE (1) YEAR from the date of original retail purchase. Glass is expressly NOT covered by this warranty.

If a defect exists, European Home will, at its option, either (1) provide needed components using new or refurbished replacement parts or (2) exchange the product with one which is new or which has been manufactured from new or serviceable used parts and is at least functionally equivalent to the original product. A replacement product/part assumes the remaining warranty of the original product or ninety (90) days from the date of replacement or repair, whichever provides longer coverage for you. When a product or part is exchanged, any replacement item becomes your property and the replaced item becomes the property of European Home. All warranty claims must be submitted through the dealer from which you purchased the product. Check with your dealer in advance for any costs to you when arranging a warranty call. Shipping and/or delivery charges for parts are not covered by this warranty.

Nothing in the above shall be deemed to imply that this warranty shall apply to work which has been abused or neglected or shows evidence of changes or modifications by others with or without permit, damages caused by the acts of God, building settlement or moving, fire or vandalism. In addition, installation of this product that varies from the requirements stated in the instruction manual will void the warranty.

PRODUCT INSTALLATION RECORD

Installer: Please complete this form.

Customer: Please retain this information.

Model (check one)	Modore 185 <input type="radio"/>
Purchased From	
Date of Purchase	
Installed By	
Date of Installation	
Fireplace Serial Number	
Fuel Type	
Total Venting Horizontal	
Total Venting Vertical	

APPENDIX ONE

MASSACHUSETTS CERTIFICATION

This appliance is approved for installation in the Commonwealth of Massachusetts. The Board of State Examiners of Plumbers and Gas Fitters has issued approval number G1-0515-495 for this appliance.

The following must be observed when installing the Element4 fireplaces within the Commonwealth of Massachusetts:

(a) For all side wall horizontally vented gas fueled equipment installed in every dwelling, building or structure used in whole or in part for residential purposes, including those owned or operated by the Commonwealth and where the side wall exhaust vent termination is less than seven (7) feet above finished grade in the area of the venting, including but not limited to decks and porches, the following requirements shall be satisfied:

1. **INSTALLATION OF CARBON MONOXIDE DETECTORS.** At the time of installation of the side wall horizontal vented gas fueled equipment, the installing plumber or gasfitter shall observe that a hard wired carbon monoxide detector with an alarm and battery back-up is installed on the floor level where the gas equipment is to be installed. In addition, the installing plumber or gasfitter shall observe that a battery operated or hard wired carbon monoxide detector with an alarm is installed on each additional level of the dwelling, building or structure served by the side wall horizontal vented gas fueled equipment. It shall be the responsibility of the property owner to secure the services of qualified licensed professionals for the installation of hard wired carbon monoxide detectors

a. In the event that the side wall horizontally vented gas fueled equipment is installed in a crawl space or an attic, the hard wired carbon monoxide detector with alarm and battery back-up may be installed on the next adjacent floor level.

b. In the event that the requirements of this subdivision can not be met at the time of completion of installation, the owner shall have a period of thirty (30) days to comply with the above requirements; provided, however, that during said thirty (30) day period, a battery operated carbon monoxide detector with an alarm shall be installed.

2. **APPROVED CARBON MONOXIDE DETECTORS.** Each carbon monoxide detector as required in accordance with the above provisions shall comply with NFPA 720 and be ANSI/UL 2034 listed and IAS certified.

3. **SIGNAGE.** A metal or plastic identification plate shall be permanently mounted to the exterior of the building at a minimum height of eight (8) feet above grade directly in line with the exhaust vent terminal for the horizontally vented gas fueled heating appliance or equipment. The sign shall read, in print size no less than one-half (1/2) inch in size, "GAS VENT DIRECTLY BELOW. KEEP CLEAR OF ALL OBSTRUCTIONS".

4. **INSPECTION.** The state or local gas inspector of the side wall horizontally vented gas fueled equipment shall not approve the installation unless, upon inspection, the inspector observes carbon monoxide detectors and signage installed in accordance with the provisions of 248 CMR 5.08(2)(a)1 through 4.

(b) **EXEMPTIONS:** The following equipment is exempt from 248 CMR 5.08(2)(a)1 through 4:

1. The equipment listed in Chapter 10 entitled "Equipment Not Required To Be Vented" in the most current edition of NFPA 54 as adopted by the Board; and

2. Product Approved side wall horizontally vented gas fueled equipment installed in a room or structure separate from the dwelling, building or structure used in whole or in part for residential purposes.

(c) **MANUFACTURER REQUIREMENTS - GAS EQUIPMENT VENTING SYSTEM PROVIDED.** When the manufacturer of Product Approved side wall horizontally vented gas equipment provides a venting system design or venting system components with the equipment, the instructions provided by the manufacturer for installation of the equipment and the venting system shall include:

1. Detailed instructions for the installation of the venting system design or the venting system components; and

2. A complete parts list for the venting system design or venting system.

(d) **MANUFACTURER REQUIREMENTS - GAS EQUIPMENT VENTING SYSTEM NOT PROVIDED.** When the manufacturer of a Product Approved side wall horizontally vented gas fueled equipment does not provide the parts for venting the flue gases, but identifies "special venting systems", the following requirements shall be satisfied by the manufacturer:

1. The referenced "special venting system" instructions shall be included with the appliance or equipment installation instructions; and

2. The "special venting systems" shall be Product Approved by the Board, and the instructions for that system shall include a parts list and detailed installation instructions.

(e) A copy of all installation instructions for all Product Approved side wall horizontally vented gas fueled equipment, all venting instructions, all parts lists for venting instructions, and/or all venting design instructions shall remain with the appliance or equipment at the completion of the installation.

APPENDIX TWO

TROUBLESHOOTING FLOW CHART

FUNCTION		POSSIBLE CAUSE	REMEDY
<p>A. Press ON button to start ignition sequence. Beep will occur each second.</p>	<p>No →</p>	Remote batteries low.	Replace remote batteries. Quality alkaline recommended.
		Receiver batteries low.	Test the batteries. replace if necessary. Quality 1.5V AA alkaline recommended. <i>Note: Do NOT connect an AC adapter when using receiver batteries.</i>
		Check that remote and receiver are synchronized.	Reset system, see the installation manual or the label on the receiver. One long beep indicates the wiring is incorrect or the code learning sequence has failed.
		Remote distance is limited.	Straighten the antenna. Replace the receiver.
		Defective AC adapter	Replace the AC adapter.
		Damaged wiring	Inspect/test all wiring and connections.
		2nd thermocouple is producing electricity.	Wait for 2nd thermocouple to cool down (3-5 minutes)
<p>Yes</p> <p>↓</p>			

(continued)

APPENDIX TWO

FUNCTION

POSSIBLE CAUSE

REMEDY

B.
Magnet unit is energized thus producing an obvious latching sound.

No →	No beep →	Impulse magnet not operating properly.	Replace gas valve.
No →	3 short beeps →	Receiver batteries low.	Test the batteries, replace if necessary. Quality 1.5V AA alkaline recommended.
No →	1 long beep →	8-wire cable is off or not operating properly.	Confirm proper operation of the 8-wire cable.
		SW-cable disconnected.	Confirm proper connection/operation of the SW-cable.
		Motor not operating properly.	Replace gas valve.
		Micro switch not operating properly.	Replace gas valve.
		ON/OFF switch is in the OFF (O) position.	If equipped, set switch to ON () position.
		2nd thermocouple not connected	Confirm integrity of 2nd thermocouple and connection.

Yes



C.
Spark will occur each second.

No →	Ignition components not operating properly.	Check connection between ignition cable and ignition electrode.
		Check ignition electrode spark gap.
		Check ignition electrode.
		Check ignition cable for damage.
		Increase distance between ignition cable and all metal parts.
No →	Ignition sequence stops after one spark	Remove ground bolt (T20 Torx, above) and clean ground lug.
No →	Ignition sequence stops, no pilot flame. No reaction to remote command.	Reset system, see the installation manual or the label on the receiver.
		Do not coil the ignition cable.
		Shorten the ignition cable, if possible.
No →	Ignition sequence stops, no pilot flame. Remote command is possible.	Test the batteries, replace if necessary. Quality 1.5V AA alkaline recommended.

Yes



(continued)

APPENDIX TWO

FUNCTION	POSSIBLE CAUSE	REMEDY
D. Pilot lit. Yes ↓	No → TC- and SW-cable reversed.	Check cable connection between receiver and interrupter block.
	Magnet unit not operating properly.	Replace gas valve.
	Short between interrupter and SW cable.	Check interrupter block connection.
	No gas (magnet unit drops after 30 second audible count.)	Check gas supply.
	Spark not lighting the pilot.	Check spark is crossing pilot orifice.
E. Sparking stops after pilot is lit. Yes ↓	No → Short between interrupter block and TC-cable.	Check connection to interrupter block.
	Electronic measuring amplifier defective.	Replace the receiver.
F. Motor turns to main gas and pilot stays lit. Yes ↓ (continued)	No → Resistance in thermocouple circuit too high.	Check thermocouple circuit.
	Magnet unit drops (audible sound) Not enough heat on thermocouple.	Check position of pilot to thermocouple. Check the stability and intensity of pilot flame. Ensure the proper restrictor is installed. Ensure that the pilot flame is properly adjusted. Possible cold start
	Low voltage from thermocouple.	Replace thermocouple. Do not over tighten - hand tight plus ¼ turn <i>maximum</i> .
	No gas (magnet unit drops after 30 second audible count.)	Check gas supply.
	No → Broken receiver	Ensure powered/unpowered receiver allows manual operation.
	No → Ignition sequence stops. No reaction to remote command.	Reset system, see the installation manual or the label on the receiver.
		Do not coil the ignition cable.
	Element4 '140' models <i>ONLY</i> : Pilot flame under hearth panel not establishing.	Remove hearth panel and glass and check for proper pilot operation. If pilot establishes with panel off then install panel and glass and adjust pilot flame (hi/lo) for best operation.

APPENDIX TWO

FUNCTION			POSSIBLE CAUSE	REMEDY						
<div style="border: 1px solid black; padding: 5px; margin-bottom: 10px;"> G. Main burner is lit. </div> <p style="text-align: center;">Yes ↓</p> <div style="border: 1px solid black; padding: 10px; min-height: 300px;"> <p style="text-align: center;">H. Main burner stays lit.</p> </div> <p style="text-align: center;">Yes ↓ (continued)</p>	No →	<table border="1" style="width: 100%; border-collapse: collapse;"> <tr> <td style="padding: 5px;">Manual knob is in the "MAN" position.</td> <td style="padding: 5px;">Turn the control knob to "ON" position, a positive latch is required.</td> </tr> <tr> <td style="padding: 5px;">Pilot flame is too low.</td> <td style="padding: 5px;">Confirm correct gas pressure. Increase pilot flame if necessary.</td> </tr> </table>	Manual knob is in the "MAN" position.	Turn the control knob to "ON" position, a positive latch is required.	Pilot flame is too low.	Confirm correct gas pressure. Increase pilot flame if necessary.				
Manual knob is in the "MAN" position.	Turn the control knob to "ON" position, a positive latch is required.									
Pilot flame is too low.	Confirm correct gas pressure. Increase pilot flame if necessary.									
	No →	<div style="border: 1px solid black; padding: 5px; text-align: center;"> System 'drops out' - all flames immediately go out </div>	→	<table border="1" style="width: 100%; border-collapse: collapse;"> <tr> <td style="padding: 5px;">Too much draft at pilot flame (poor flame impingement of primary thermocouple.)</td> <td style="padding: 5px;">Check venting installation. Use restrictor as required.</td> </tr> <tr> <td style="padding: 5px;">Pilot assembly out of order.</td> <td style="padding: 5px;">Inspect pilot assembly for correct operation and thermocouple impingement.</td> </tr> <tr> <td style="padding: 5px;">5 day shut off.</td> <td style="padding: 5px;">The system shuts off the fire and pilot if there is no change in the flame height for 5 days.</td> </tr> </table>	Too much draft at pilot flame (poor flame impingement of primary thermocouple.)	Check venting installation. Use restrictor as required.	Pilot assembly out of order.	Inspect pilot assembly for correct operation and thermocouple impingement.	5 day shut off.	The system shuts off the fire and pilot if there is no change in the flame height for 5 days.
Too much draft at pilot flame (poor flame impingement of primary thermocouple.)	Check venting installation. Use restrictor as required.									
Pilot assembly out of order.	Inspect pilot assembly for correct operation and thermocouple impingement.									
5 day shut off.	The system shuts off the fire and pilot if there is no change in the flame height for 5 days.									
	No →	<div style="border: 1px solid black; padding: 5px; text-align: center;"> Main burner remains lit while flames are lowered. (Main valve knob is turned via motor.) </div>	→	<table border="1" style="width: 100%; border-collapse: collapse;"> <tr> <td style="padding: 5px;">2nd thermocouple is not heated.</td> <td style="padding: 5px;">Ensure 2nd thermocouple is heated by a robust flame. The fireplace media may be interfering with proper flame. Check 2nd thermocouple wiring.</td> </tr> <tr> <td style="padding: 5px;">2nd thermocouple shut off.</td> <td style="padding: 5px;">The system shuts off the fire when the main burner flame is not sensed within 22 seconds of ignition or not sensed after pressing the <i>large flame</i> button. Note: If the system fails to light due to the 2nd thermocouple voltage not being sensed a two minute lockout period begins. This lockout time allows the gas to dissipate.</td> </tr> </table>	2 nd thermocouple is not heated.	Ensure 2 nd thermocouple is heated by a robust flame. The fireplace media may be interfering with proper flame. Check 2 nd thermocouple wiring.	2 nd thermocouple shut off.	The system shuts off the fire when the main burner flame is not sensed within 22 seconds of ignition or not sensed after pressing the <i>large flame</i> button. Note: If the system fails to light due to the 2 nd thermocouple voltage not being sensed a two minute lockout period begins. This lockout time allows the gas to dissipate.		
2 nd thermocouple is not heated.	Ensure 2 nd thermocouple is heated by a robust flame. The fireplace media may be interfering with proper flame. Check 2 nd thermocouple wiring.									
2 nd thermocouple shut off.	The system shuts off the fire when the main burner flame is not sensed within 22 seconds of ignition or not sensed after pressing the <i>large flame</i> button. Note: If the system fails to light due to the 2 nd thermocouple voltage not being sensed a two minute lockout period begins. This lockout time allows the gas to dissipate.									
	No →	<div style="border: 1px solid black; padding: 5px; text-align: center;"> System goes to pilot flame only. </div>	→	<table border="1" style="width: 100%; border-collapse: collapse;"> <tr> <td style="padding: 5px;">6 hours of no motor movement.</td> <td style="padding: 5px;"> In Manual/Temperature/Timer modes the valve turns down to pilot only if the flame height does not change for a 6 hour period. In Temperature/Timer modes if the ambient room temperature changes, the flame height will adjust automatically to maintain the set temperature and the fire will continue to function normally. The valve will turn to pilot flame if the set temperature and the ambient temperature remain the same over a 6 hour period. </td> </tr> </table>	6 hours of no motor movement.	In Manual/Temperature/Timer modes the valve turns down to pilot only if the flame height does not change for a 6 hour period. In Temperature/Timer modes if the ambient room temperature changes, the flame height will adjust automatically to maintain the set temperature and the fire will continue to function normally. The valve will turn to pilot flame if the set temperature and the ambient temperature remain the same over a 6 hour period.				
6 hours of no motor movement.	In Manual/Temperature/Timer modes the valve turns down to pilot only if the flame height does not change for a 6 hour period. In Temperature/Timer modes if the ambient room temperature changes, the flame height will adjust automatically to maintain the set temperature and the fire will continue to function normally. The valve will turn to pilot flame if the set temperature and the ambient temperature remain the same over a 6 hour period.									

APPENDIX TWO

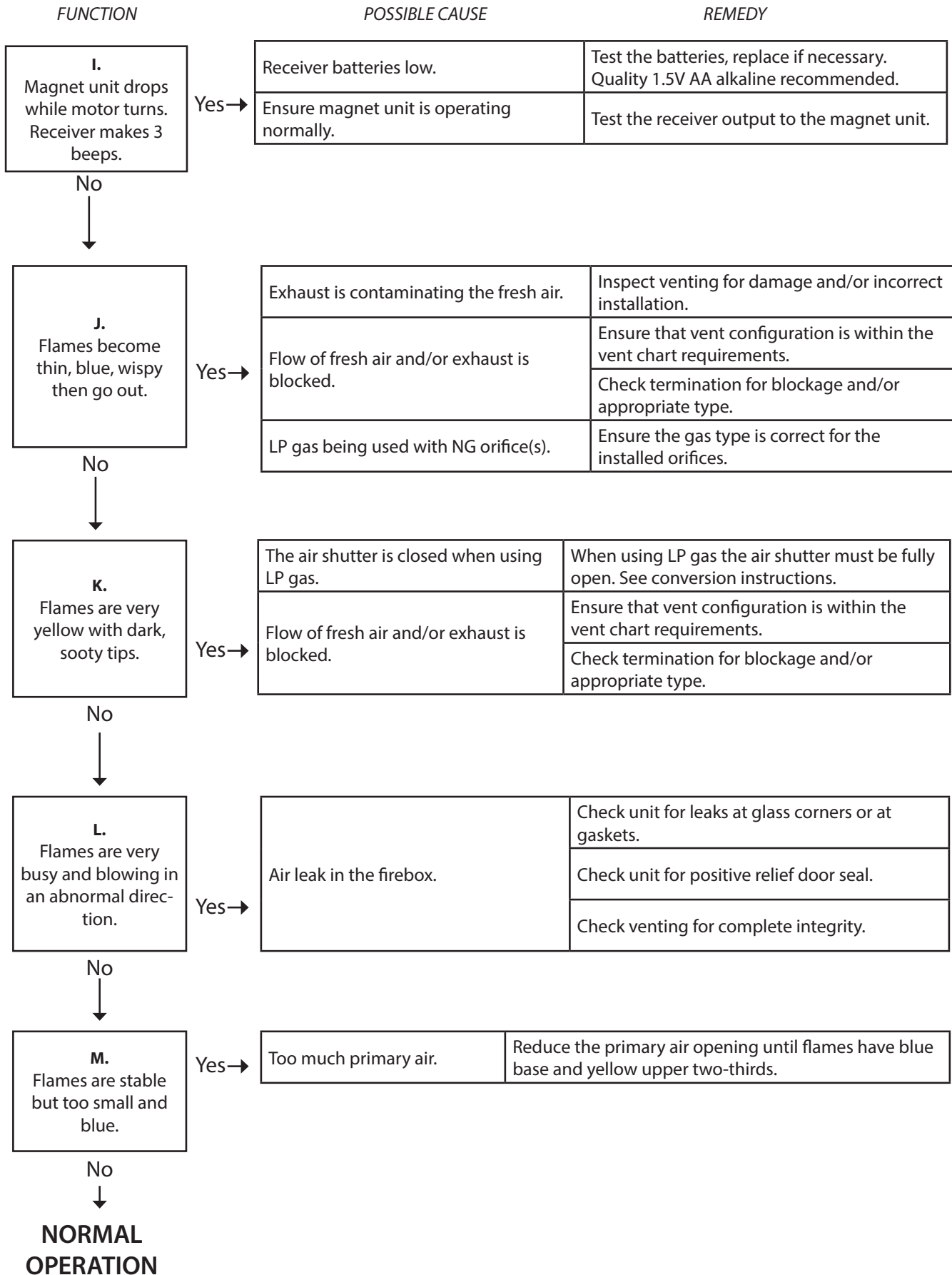

APPENDIX THREE

INSTALLING AN OPTIONAL WALL SWITCH

1. Install a single-gang electrical workbox (not supplied) at the desired location - no more than 26 feet as the cable runs.
2. While keeping the black connector (A) inside the work box, thread the black 4-wire cable through the workbox and bring the red connector (B) to the location of the receiver.
3. Connect the black connector (A) to the wall switch, the red connector (B) to the receiver.
4. Test for proper operation then screw the wall switchplate to the workbox with the two screws provided and attach the faceplate (included).

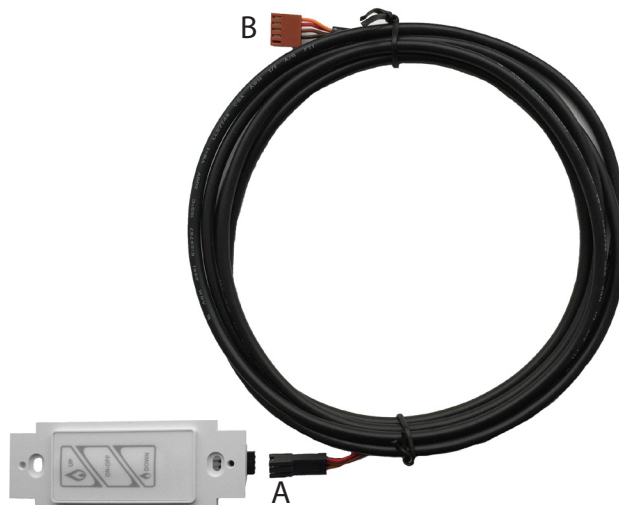

USING THE WALL SWITCH

Note that, with the wall switch, you can turn the fireplace on and off and adjust the flames up and down. *The rear burner, however, can only be turned on/off with the remote control (model applicable).*

- Turn fireplace ON: Press the ON/OFF button until a short beep confirms the start sequence has begun then release the button.
- Increase the flame height: Press and hold the UP button.
- Decrease the flame height: Press and hold the DOWN button.
- For fine adjustment tap the UP or DOWN button as necessary.
- Turn fireplace OFF: Press the ON/OFF button.

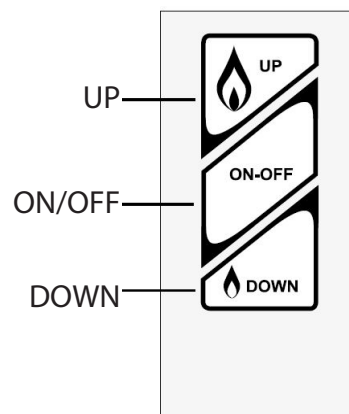

APPENDIX FOUR

CONNECTING TO A SMART HOME SYSTEM (Smart Home System Cable)

GENERAL NOTES

The fireplace may be operated through an external source such as a smart home (home automation) system by using the 5-pin connector on the receiver.

A required 39"/1000 mm cable, with connector, is available (part number E4-SA-SHSC-02). The overall cable length should not exceed 26'/8000 mm.

Signal relays (gold contacts) or opto-couplers are recommended but not supplied. The E4-SA-SHSC-02 cable must be connected to the three smart home system contacts as shown below.



WARNING



You MUST ensure that the fireplace is in a safe and ready condition before attempting to operate from a remote source.

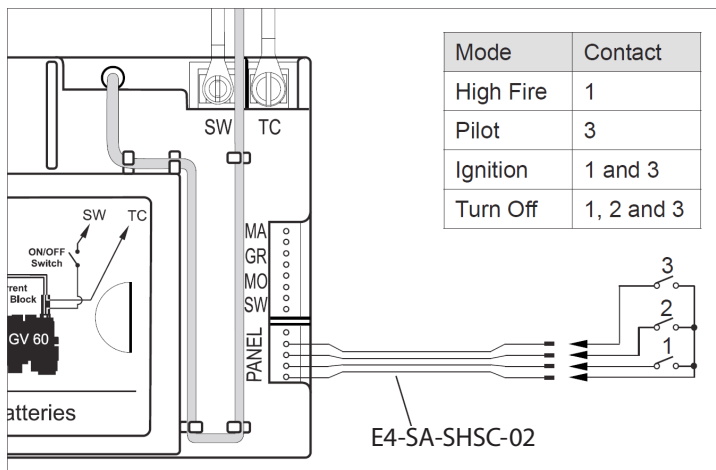

SEQUENCE OF OPERATION

- To start ignition, close contacts 1 and 3 simultaneously for 1 second.
- To set the valve to High Fire, close contact 1.
To set the valve to Pilot, close contact 3. In each case, the contacts need to be closed for 12 seconds to turn the motor from one end-stop to the other end stop.
- To set the valve to the Off position, close contacts 1, 2, and 3 simultaneously for 1 second.

MODES OF OPERATION

- Mode 1 - the external source provides "ON" and "OFF" operation only. The remote control handset provides all other functions.
Note: Even if the fire is switched on by the external source, the handset, in the thermostatic mode, controls the room temperature. The room temperature setting of the handset will remain the same for the next ON-cycle of the external source as long as the temperature setting in the handset has not been changed. If the handset is in manual mode, it will go to High Fire in the next cycle of external operation.
- Mode 2 - The handset must be set to the manual mode if the external source is to control the room temperature. If the handset is placed in the thermostatic mode it will override the external source.

NOTE:

Frequent ON and OFF cycles will limit life expectancy of the valve and will increase battery consumption. The fireplace should be powered by the AC adapter for improved reliability and customer satisfaction.

INDEX

- A**
APPLIANCE RATINGS **8**
AC ADAPTER SPECIFICATIONS **8**
- C**
CERTIFICATION
LISTING LABEL **8**
MASSACHUSETTS **50 (Appendix 1)**
CLEARANCES
CLEARANCES **13**
LOCATION **12**
MANTELS **14**
CONVECTION AIR OUTLET(S) **15**
- E**
ELECTRIC
REQUIREMENTS **16**
AC ADAPTER SPECIFICATIONS **8**
ENCLOSING THE FIREPLACE **23**
- F**
FIRE MEDIA
INSTALLING THE LOGSET **33**
INSTALLING THE STONES **34**
FIRST FIRE **44**
- G**
GAS
CONVERTING TO LP **48**
INSTALLING THE GAS LINE **16**
PRESSURES **8**
- K**
KEY INSTALLATION POINTS **6**
- L**
LISTING LABEL **8**
LP (PROPANE) CONVERSION **48**
- M**
MAINTENANCE
BURNER **47**
GLASS **45**
PILOT **47**
THERMOCOUPLES **48**
VENT **48**
MANTELS **14**
- N**
NON-COMBUSTIBLE MATERIALS
MINIMUM CLEARANCES **13**
- O**
OPERATING THE FIREPLACE
TEST FIRE **32**
USING THE REMOTE CONTROL **38**
USING THE WALL SWITCH **56 (Appendix 3)**
- P**
PARTS OF THE FIREPLACE **10**
- S**
SAFETY INFORMATION **3**
SCREEN INSTALLATION **35**
SMART HOME SYSTEM **57 (Appendix 4)**
SPECIFICATIONS
APPLIANCE RATINGS **8**
MODORE 185 DIMENSIONS **9**
- T**
TROUBLESHOOTING **51 (Appendix 2)**
- V**
VENTING
CONFIGURATION **17**
HORIZONTAL TERMINATIONS **20**
VERTICAL TERMINATIONS **20**
RESTRICTOR **20**
CLEARANCES **21**
- W**
WALL ACCESS DOOR **30**
WALL SWITCH **56 (Appendix 3)**
WARRANTY **49**

NOTES

Imported and distributed in North America by:



EuropeanHome

EUROPEAN HOME

a division of Europa Ja, Inc.

30 Log Bridge Road

Building 300 - Suite 303

Middleton, MA 01949

www.europeanhome.com